

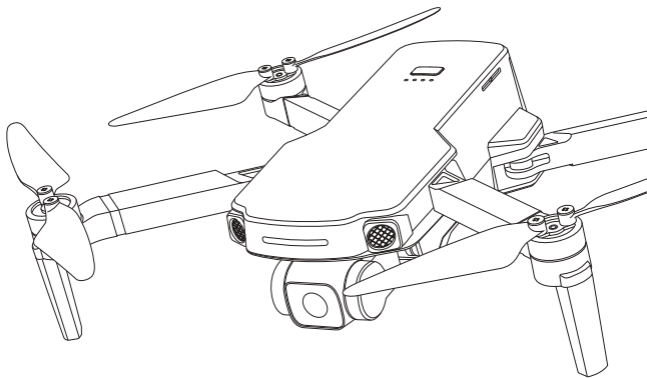

# HS360D

User Manual | **V1.1**



 +1(833)766-4733

 [usa@holystone.com](mailto:usa@holystone.com) (USA)

[ca@holystone.com](mailto:ca@holystone.com) (CA)

[eu@holystone.com](mailto:eu@holystone.com) (EU)

[au@holystone.com](mailto:au@holystone.com)(AU)

# CONTENTS

---

## 1

### Product Profile

---

- 01 Package Contents
- 02 Diagram of the Drone
- 03 Diagram of the Transmitter

## 2

### Operation Guidance

---

- 08 Charging
- 10 Pre-Flight Preparations
- 14 Pre-Flight Checklist
- 15 Flight

## 3

### Drone Functions

---

- 23 Flight Functions
- 31 APP Functions
- 43 Stabilization Function

## 4

### Appendix

---

- 45 Specifications
- 46 Contact Information
- 47 Troubleshooting
- 48 Compliance Information

# Reading Guidance

## Icon

“” essential precautions.

“” tips for operation and usage.

## Recommended Steps

**Our product offers both tutorial videos and the following resources:**

- Quick Start Guide
- User Manual
- Disclaimer and Safety Guidelines

For a smooth start, we suggest watching the tutorial videos and reviewing the "Disclaimer and Safety Guidelines" first. Then, familiarize yourself with the basics through the "Quick Start Guide". For a comprehensive understanding, delve into the "User Manual".

## Access Tutorial Videos

To ensure you're using the product safely and correctly, scan the QR code below to view our tutorial videos.



## Download the HS FLY App

Simply scan the QR code below.



iOS



Android APP on Google play



The interface and functions of HS FLY may vary as the software version is updated. Actual user experience is based on the software version used.

## 1.1 Package Contents >>

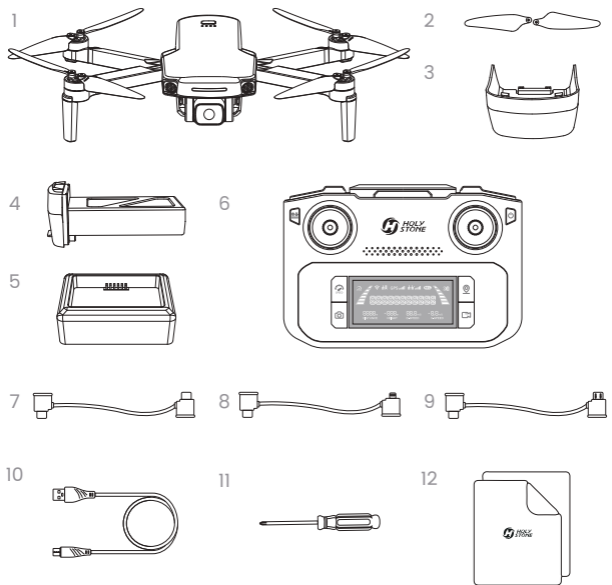

1 Drone

2 Propellers

3 Camera Cover

4 Drone Battery

5 Charging hub

6 Transmitter

7 Connection Cable  
(type-c)8 Connection Cable  
(lightning)9 Connection Cable  
(micro-USB)

10 USB Charging Cable

11 Screwdriver

12 User Manual

## 1.2 Diagram of the Drone >>

### Drone

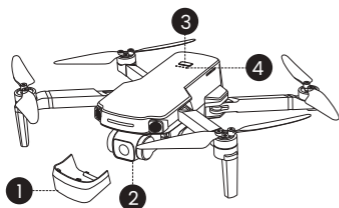

- 1 Camera Cover
- 2 Camera
- 3 Power Button
- 4 Battery Level Indicators

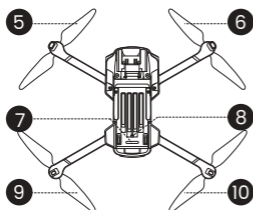

- 5 Propeller B
- 6 Propeller A
- 7 Drone Status Indicator
- 8 Optical Flow Lens
- 9 Propeller A
- 10 Propeller B

**Turn On/Off:** Turn the battery on/off by **pressing the power button (⏻) for 3 seconds**. When the battery is on, the battery level indicators will display the current battery status. When the battery is powered off, all the indicators are out.

## 1.3 Diagram of the Transmitter >>

### Transmitter

#### • Front:

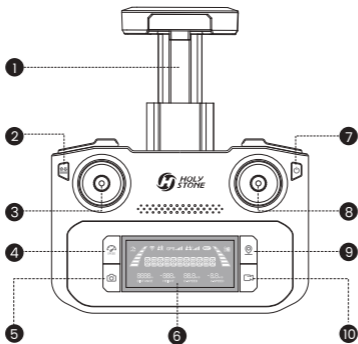

**1** Cellphone Holder

**3** Left Joystick

**5** Take Photo

**7** Check Battery Level: Short Press  
Power Button: Short press, then hold

**9** Return to Home: Short Press  
GPS Switch on/off: Long Press

**2** Takeoff/Landing: Short Press  
Emergency Stop: Long Press

**4** Speed Switch: Short Press  
Cruise Control: Long Press

**6** LCD Screen

**8** Right Joystick

**10** Record Video

## 1.3 Diagram of the Transmitter >>

### Transmitter

#### • Top:

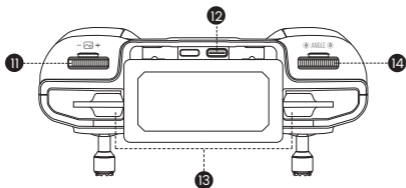

#### • Bottom:

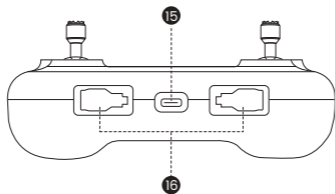

11 Zoom Dial

12 Connection Port

13 Cellphone Slot

14 Camera Adjustment Dial

15 Charging Port

16 Storage Slots for Joysticks

## 1.3 Diagram of the Transmitter >>

### LCD Screen



- |                                  |                                      |
|----------------------------------|--------------------------------------|
| <b>1</b> Transmitter WiFi Signal | <b>2</b> Transmitter Battery Level   |
| <b>3</b> GPS Signal Strength     | <b>4</b> Transmitter Signal Strength |
| <b>5</b> Camera Status           | <b>6</b> Flight Speed                |
| <b>7</b> Drone Status            | <b>8</b> Drone Battery Level         |
| <b>9</b> Flight Distance         | <b>10</b> Flight Height              |
| <b>11</b> Horizontal Speed       | <b>12</b> Vertical Speed             |

**!** When the battery level of the transmitter is low, its icon (  ) will start to flash. When this happens, please bring the drone down to the ground immediately and charge the transmitter.

## 1.3 Diagram of the Transmitter >>

### Joystick Mode

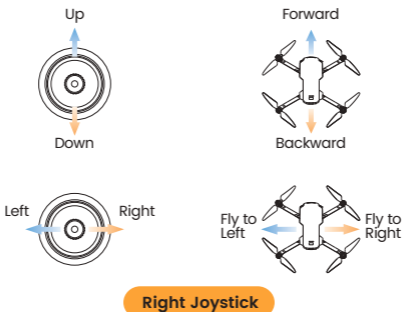
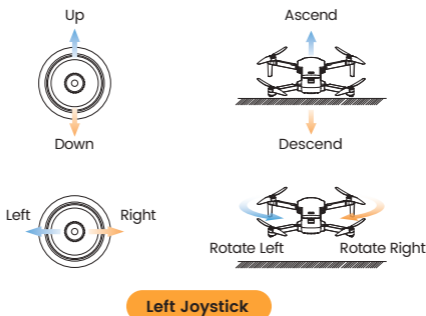

- **Mode 2:** (Left joystick as the throttle joystick)



## 1.3 Diagram of the Transmitter >>

### Joystick Mode

- **Mode 1:** (Right joystick as the throttle joystick)

Hold the (  ) button, short press the (  ) button of the transmitter once, then hold the latter until the transmitter quickly beeps 3 times. You will see "R HAND MODE" displayed on the LCD screen, which means the transmitter is now in Mode 1.

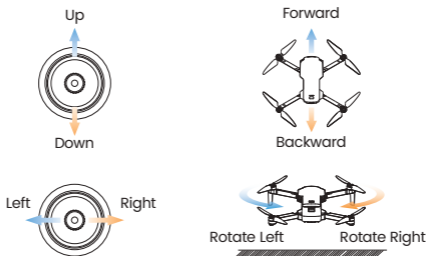

Left Joystick

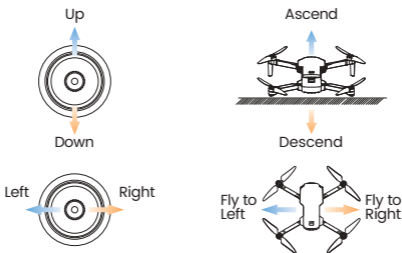

Right Joystick

## 2.1 Charging >>

### • Charging of the Transmitter:

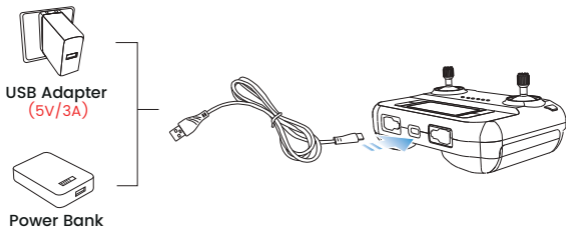

- 1 Insert the Type-C plug of the charging cable into the Type-C port of the transmitter.
- 2 Plug the other end of the cable into a USB adapter (5V/3A) or power bank to start charging.
- 3 When charging, the cells in the battery level bar will light up in turn. The LCD screen displays "**CHARGING.**" When the charging is done, all 3 cells will light up (  ) and the LCD screen displays "**CHARGE DONE.**"
- 4 It takes about 110 minutes to fully charge the transmitter. A fully charged transmitter offers about 2.5 hours of usage time.

- ! The transmitter cannot be turned on while it is charging.
- Before charging, please read the instructions in the "Battery Safety" section of the "Disclaimer and Safety Guidelines" carefully!
- Please use the original charging cable to charge the transmitter.

## 2.1 Charging >>

### • Charging of the Drone Battery:

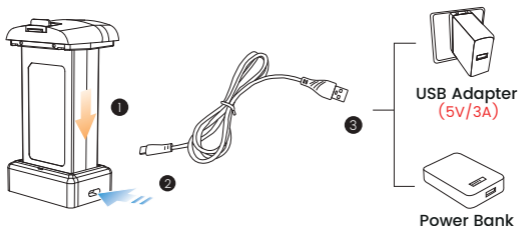

- 1 Insert the batteries into the charging hub and connect the hub to a Type-C charging cable.
- 2 Plug the other end of the cable into a USB adapter (5V/3A) or power bank to start charging.
- 3 During charging, the lights on the hub will flash green; when fully charged, they will turn solid green. If no battery is inserted, the light will remain solid red.
- 4 It takes about 3 hours to fully charge a drone battery.

- ⚠ Before charging, please read the instructions in the "Battery Safety" section of the "Disclaimer and Safety Guidelines" carefully!
- Please use the original charging cable to charge the drone battery.

## 2.2 Pre-Flight Preparations >>

### Arms

- Unfold the **front** arms
- Unfold the **rear** arms

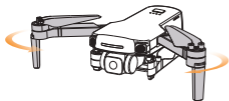

All arms of the drone are folded when it is packaged at the factory. First, unfold the front arms, then unfold the rear arms.

### Camera Cover

A

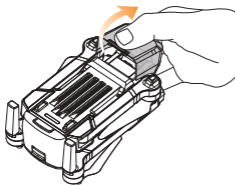

Loosen the buckle on the camera cover.

B

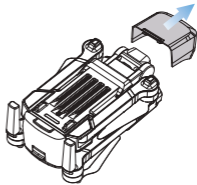

Gently pull the cover up, then pull it toward the front of the drone.



Please remove the camera cover before you turn on the drone.

## 2.2 Pre-Flight Preparations >>

### Drone Battery

#### ● Installation:

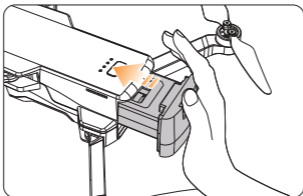

Push the battery into the fuselage. Make sure you hear a click when inserting the battery, which indicates that it is installed firmly.

---

#### ● Removal:

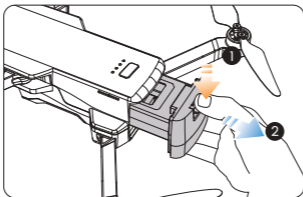

Press down on the snap and pull the battery out of the fuselage.



- Please make sure that the battery is firmly installed. Otherwise, the flight safety of your drone may be affected. The drone may crash due to a power-cut during the flight.
- Only install/remove the battery when it is powered off.

## 2.2 Pre-Flight Preparations >>

### Propeller

#### ● Installation:

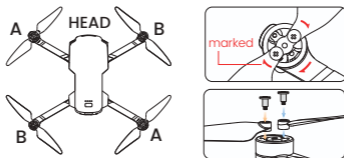

Install the marked propellers to the marked motor shafts. Use the screwdriver to tighten the two screws in place. Install then the unmarked propellers to the unmarked motor shafts.

#### ● Removal:

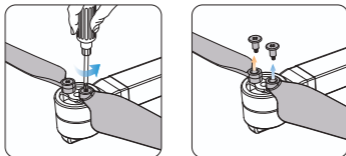

Use the screwdriver to turn the screws anti-clockwise to remove them. Then pull the propellers up.

- ⚠ • The marked propellers have a different spin direction than the unmarked ones. So please ensure that they are installed to the right motor shafts.
- Before each flight, check if the propellers are secure and tight.
- If the propellers become deformed or damaged, please replace them before flying again.

## 2.2 Pre-Flight Preparations >>

### TF Card

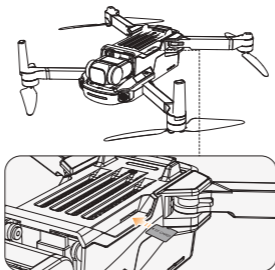

Insert a TF card (**not included**) into the TF card slot before turning on the drone. This drone supports TF card with a max storage of 256GB.

### Joysticks

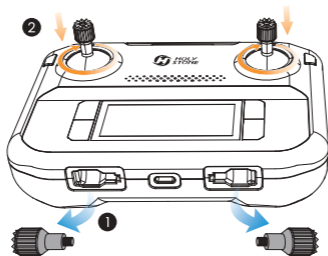

Take the joysticks out of the storage slot and mount them onto the transmitter.

## 2.3 Pre-Flight Checklist >>

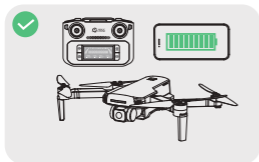

Make sure the transmitter, the cellphone and the drone battery are fully charged.

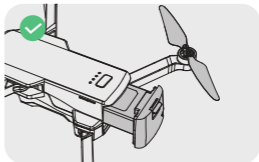

Make sure the drone battery and the propellers are installed securely.

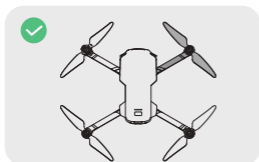

Make sure the drone arms and propellers are fully expanded.

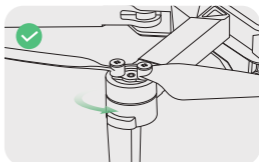

Make sure that there is nothing obstructing the motors.

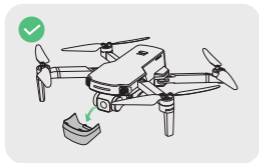

Make sure the camera cover is removed.



Make sure you use accessories provided by this company.

## 2.4 Flight >>

### Pairing



- All of the operations shown in this manual are demonstrated using MODE 2.
- Make sure that you go outdoor to an open area to operate the drone.

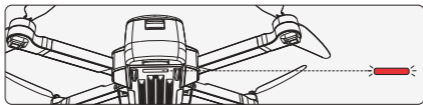
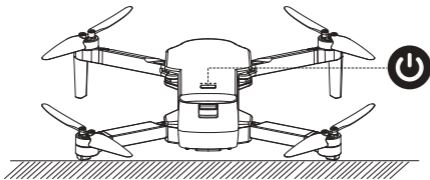

### 1 Turning on the drone

Press and hold the power button (  ) for 3 seconds to turn on the drone. **Place it on a level surface with its head pointing forward.** The drone status indicator starts to blink red. The drone is now waiting to be paired.

## 2.4 Flight >>

### Pairing

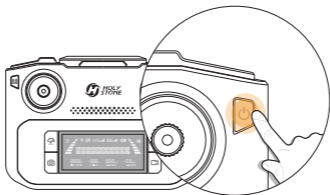

#### 2 Turning on the transmitter

Short press the power button (  ) once, then press and hold for 3 seconds to turn it on.



Short pressing the button once will only display the battery level.

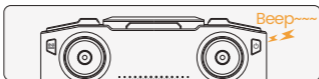
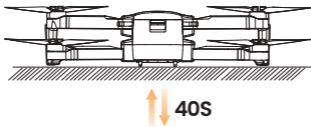

#### 3 Auto-Pairing

It takes about **40 seconds** to pair the transmitter with the drone. During the pairing, the transmitter will keep on beeping. Finally, it will long beep once indicating that the pairing is complete.

## 2.4 Flight >>

### App Connection

- 1 Cellphone connection:** Pull out the phone holder. Select the appropriate connection cable (Type-C, Micro-USB, or Lightning) from the package. Connect the end marked with a transmitter icon (  ) to the transmitter and plug the other end into your cellphone.

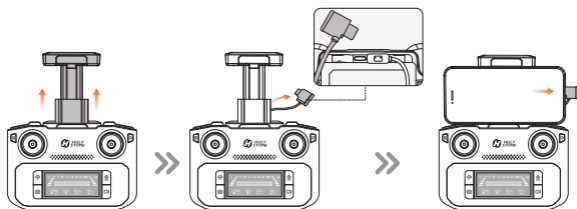

- 2** Run the "HS FLY" app and open up the live-feed interface.



HS FLY App



When using an Android phone, please choose "charge only" when the cellphone asks you to choose a connection mode. Other options may cause the connection to fail.

## 2.4 Flight >>

### Compass Calibration

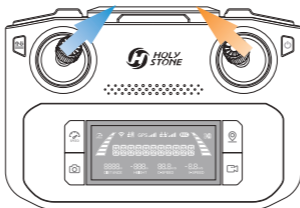

#### ● STEP 1

Push both joysticks **towards the inner, upper corners** simultaneously to start the compass calibration.

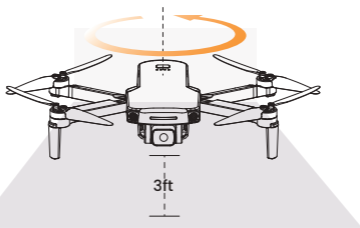

#### ● STEP 2

Rotate the drone horizontally (**keeping it parallel to the floor**) until the transmitter beeps once.

## 2.4 Flight >>

### Compass Calibration

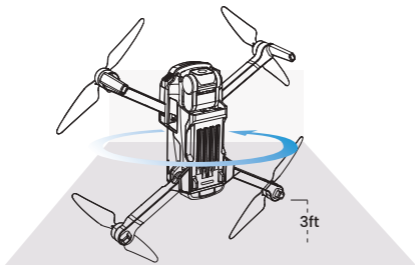

#### ● STEP 3

Point the head of the drone **upward and rotate it** till the transmitter beeps again. The compass calibration is complete.



- To ensure a stable flight, we recommend that pilots perform a compass calibration before each flight.
- We recommend that the pilot hold the drone approximately 3 ft above the ground while performing the compass calibration.
- DO NOT calibrate the compass in locations where magnetic interference may occur, such as close to magnetite deposits or large metallic structures such as parking structures, steel reinforced basements, bridges, cars, or scaffolding.
- DO NOT carry objects (such as mobile phones) that contain ferromagnetic materials near the drone during calibration.

## 2.4 Flight >>

### GPS Signal Search



Please don't use the GPS mode when you are indoors.

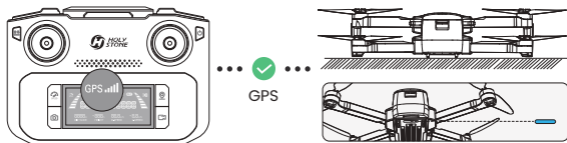

After calibrating the compass, put the drone on a flat surface. Make sure there are no external sources of signal interference around.

The drone will automatically perform a search for GPS signals. The drone has successfully located the GPS signal when the drone status indicator turns solid blue.



The drone status indicator will keep flashing blue slowly, indicating that the GPS search is still in progress.

**Exit GPS Mode:** If the GPS signal is weak, or if you plan to fly the drone indoors, press and hold the (  ) button on the transmitter for 2 seconds to exit GPS mode for a proper takeoff. The LCD screen will then display "ATTI MODE", indicating that the drone has entered Attitude Mode. In this mode, the drone can take off, but please be aware that all GPS-related functions will be unavailable.

## 2.4 Flight >>

### Unlocking the Motors

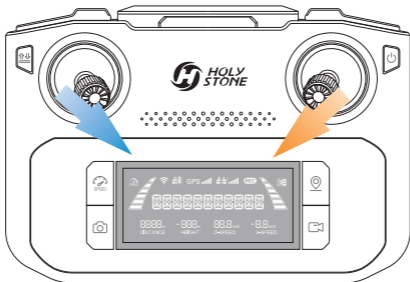

Push both of the joysticks simultaneously toward the inner, lower corners. The motors start to spin, the drone is unlocked.

 **Locking:** If no command is given, the motors will lock themselves automatically 15s after the they are unlocked. You can also push both of the joysticks to the inner corners to manually lock them.

## 2.4 Flight >>

### Takeoff/Landing



#### Takeoff

Short press the (↑↓) button, the drone will take off automatically and hover at 5 ft. Now you can control the drone by using the joysticks.



#### Landing

When the drone is in the air, short press the (↑↓) button. The drone slowly descends to the ground.



When operating the drone, it's important to periodically adjust the orientation and distance between the transmitter and the drone to ensure that the drone always remains within the optimal communication range.

#### Optimal Reception Range:



#### Weaker Signal:

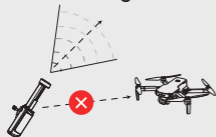

## 3.1 Flight Functions >>

### Zoom

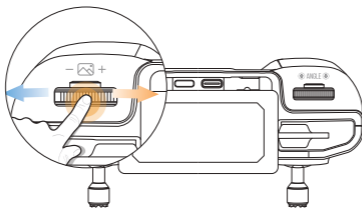

To zoom in, scroll the zoom dial (-📷+) to the right. The LCD screen displays **"ZOOM IN."**

To zoom out, scroll the zoom dial (-📷+) to the left. The LCD screen displays **"ZOOM OUT."**

### Camera Adjustment





Adjust the camera angle by scrolling the camera adjustment dial (Ⓢ ANGLE Ⓢ) (tilt range: -90°~ 0°)

## 3.1 Flight Functions >>

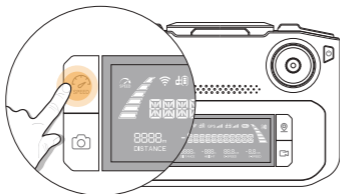
### Speed Switch



Short press the (  ) button once to switch speed. The Camera Mode is 9.84 ft/s. The Normal Mode is 16.4 ft/s. The Sport Mode is 22.97 ft/s.

 The normal mode is the default setting.

#### • Low:



The transmitter beeps once. The LCD screen displays "**CAMERA MODE**" (  ).

#### • Middle:



The transmitter beeps twice. The LCD screen displays "**NORMAL MODE**" (  ).

#### • High:





The transmitter beeps 3 times. The LCD screen displays "**SPORT MODE**" (  ).

## 3.1 Flight Functions >>

### Cruise Control

The cruise control function locks the current joystick input, allowing the drone to maintain a constant speed and direction.

- 1 ACTIVATING:** During flight, push the right joystick in the desired direction and then press and hold the (  ) button. The drone will automatically continue flying at the current speed and direction, and you may release the joystick.
- 2 DEACTIVATING:** To exit cruise control, press the (  ) button again—either a short or long press will work.

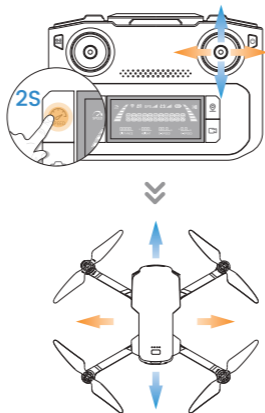



Cruise control can only be activated when the flight altitude exceeds 50 ft.

### 3.1 Flight Functions >>

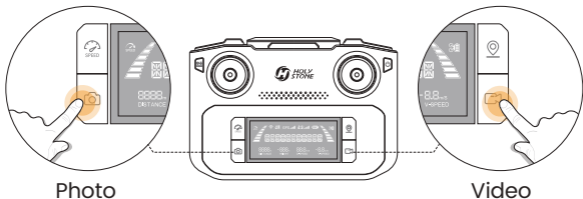
#### Photo/Video





- 1 Short press the (  ) button on the transmitter. The ( **REC** ) on the LCD screen flashes once, which means that you have successfully taken a photo.
- 2 Short press the (  ) button on the transmitter. The ( **REC** ) on the LCD screen starts to blink, which means the camera is recording. Short press the button again will stop video recording.

 During the recording, the "Take Photo" function is disabled.

## 3.1 Flight Functions &gt;&gt;

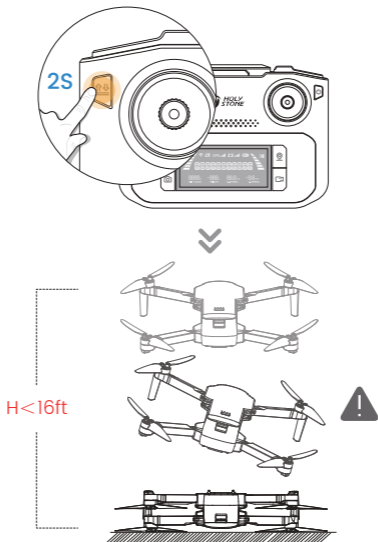
## Emergency Stop



Hold the (  ) button for 2 seconds to use Emergency Stop. This function only works when the drone's altitude is lower than 16 ft.

 The Emergency Stop function should only be used in case of emergency during the flight to avoid any damage or injury.

## 3.1 Flight Functions >>

### Return to Home

- The Return to Home (RTH) function brings the drone back to the recorded Home Point. This function can only be triggered when the drone is in GPS mode.
- The drone's default home point is the location where it first receives a strong GPS signal (When this occurs, the icon for GPS signal strength (  ) on the LCD screen lights up). The drone will record its takeoff position at that moment as the home point. During flight, if the drone lands at a new location, the position of the next takeoff will become the newly recorded home point.

\* **RA:** the Return Altitude set in the app setting.

#### 1 Smart RTH:

Short press the (  ) button to activate Smart RTH. The drone will fly back to the last recorded Home Point.

During Smart RTH, the transmitter will keep on beeping. Short press the (  ) button again to exit Smart RTH.

#### 2 Failsafe RTH:

The Failsafe RTH will be activated when:

1. The drone receives a strong GPS signal ; and
2. there is a pre-recorded Home Point; and
3. the connection between the transmitter and the drone is lost; and
4. the compass has no interference.

Once the Failsafe RTH is activated, the transmitter will beep. The drone will start to fly back to the pre-recorded Home Point automatically. If the connection between the drone and the transmitter is re-established during the Failsafe RTH procedure, the pilot can manually end the RTH procedure by pressing the (  ) button again, thus regaining control of the drone.

## 3.1 Flight Functions >>

### Return to Home

-  The following are three possible returning procedures for Smart RTH and Failsafe RTH:

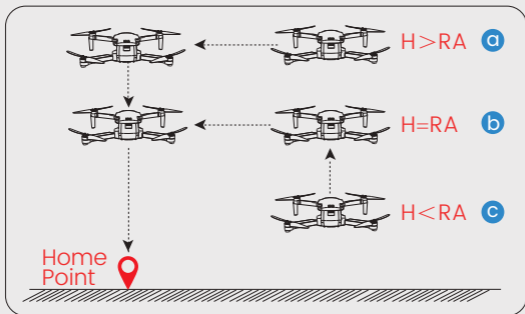

- a Flight altitude > RA:** When the drone's current altitude is higher than RA, the drone will maintain its current altitude, fly back above the Home Point, then descend to the ground.
- b Flight altitude = RA:** When the drone's current altitude is equal to RA, the drone will maintain its current altitude, fly back above the Home Point, then descend to the ground.
- c Flight altitude < RA:** When the drone's current altitude is lower than RA, the drone will first ascend to RA, fly back above the Home Point, then descend to the ground.

## 3.1 Flight Functions >>

### Return to Home

#### 3 Low Voltage RTH:

When the flight battery is too low or there is not enough power to return home, the pilot should land the drone as soon as possible to avoid damage to the drone or other hazards.

To prevent unnecessary risks due to insufficient battery power, the low voltage RTH function will be automatically triggered when the drone battery is low. According to the remaining power, there are two scenarios:

**The First Stage of Low Voltage RTH:** The drone automatically flies back and hover over the Home Point. While the drone is returning, the transmitter emits a continuous beep. The LCD screen displays "GOING HOME."

After the drone returns, you will be restricted to flying it within a "safety zone", which is centered around the Home Point and has a radius of 98 ft and a height of 66 ft. The drone will not be able to exit this zone.









**The Second Stage of Low Voltage RTH:** The drone returns directly to the Home Point and initiates an automatic landing.

- ⚠ · During the RTH procedure, the drone can NOT avoid obstacles.
- If the GPS signal is weak or unavailable, the RTH cannot be activated.
- Always keep the transmitter ON during flights. Turning it off will trigger the Failsafe RTH due to a lost connection.

## 3.2 APP Functions >>













### The Interface



- 1  **Homepage** : Tap this icon to return to the main menu.
- 2  **System Status** : Displays the flight status and various warning messages.
- 3  **Interference Index of Compass** : Displays the current level of electromagnetic interference. "0" means no interference, "1000" means max. interference.
- 4  **Transmitter Battery Level** : Real-time display of the current battery level of the transmitter.
- 5  **GPS Signal** : Displays current GPS signal strength.
- 6  **Drone Battery Level** : Real-time display of the current battery level of the drone.
- 7  **Settings** : Tap to enter the setting interface. Alter settings for flight height/distance, return altitude, etc.
- 8  **Takeoff/Landing** : Tap the icon, follow the instructions in the prompt box to takeoff/land.













## 3.2 APP Functions >>

### The Interface

- 9  **Return to Home** : The drone returns to the last recorded Home Point.
- 10  **Multi-functions**
- 11  **Image Follow** : After selecting a target, the camera will always point towards it no matter how the target moves. The position of the drone in the air remains unchanged. (The target should not move too fast.)
- 12  **GPS Follow** : The drone stays at a distance from the operator and follows the GPS position of the paired mobile phone.
- 13  **VR Screen-Split** : Pair the mobile phone with a pair of VR glasses (not included) first. Then use this function to watch 3D live feed in real-time.
- 14  **Point of Interest** : The drone flies around a point.
- 15  **Catapult** : The drone flies backward and ascends, with the camera locked on the subject. A video is made during this.
- 16  **One-key Ascension** : The drone ascends with the camera locked on the subject. A video is made during this.
- 17  **Gesture Selfie** : When in this mode, you can trigger the shutter of the drone camera by holding a "V" -sign near your face. (The drone camera should be pointing to your face.)
- 18  **Gesture Selfie Video** : When in this mode, you can trigger the shutter of the drone camera by holding your palm near your face. (The drone camera should be pointing to your face.)
- 19  **TapFly** : The drone flies along the flight path you draw on the screen of the mobile phone.
- 20  **Camera Filter**
- 21  **Spiral Up** : The drone ascends and spiral around the subject. A video is made during this.

## 3.2 APP Functions >>

### The Interface

- 22  **Portrait** : The shooting mode will turn from landscape to portrait.
- 23  **Camera Settings** : Tap to access and configure camera parameters.
- 24  **Shooting Mode**
- 25  **Take Photo** : Tap to use the photo function.
- 26  **Record Video** : Tap to use the record function.
- 27  **Time-lapse** : Videos captured using this feature will be played back at a faster speed. You can select the playback rate as needed.
- 28  **Slow Motion** : Videos captured using this feature will be played back at a slower speed. You can select the playback rate as needed.
- 29  **Panorama** : Tap to use the Panorama function.
- 30  /  **Shutter**
- 31  **Album** : Tap to preview photos and videos taken by the drone camera.
- 32  **Voice Recording** : Record sounds and voices with your mobile phone while shooting videos.
- 33  **Map** : Tap the Mini Map to switch between Camera View and Map View.
- 34 **Flight Parameters**
- $\frac{D}{N/Am}$  **Flight Distance** : Horizontal distance from the Home Point.
  - $\frac{H}{N/Am}$  **Flight Altitude** : Vertical distance from the Home Point.
  - $\frac{DS}{N/A m/s}$  **Horizontal Speed** : Drone's speed in the horizontal direction.
  - $\frac{VS}{N/A m/s}$  **Vertical Speed** : Drone's speed in the vertical direction.

## 3.2 APP Functions >>

### Beginner Mode

The beginner mode is the default operating mode. When in the Beginner mode:

- 1 The flight distance can not exceed 98 ft.
- 2 The flight altitude can not exceed 98 ft.
- 3 The return altitude during RTH is 66ft.

If you want to alter the above-mentioned parameters, please first turn off the beginner mode. You can go to the "Settings" to modify these parameters.



### Flight Settings On APP

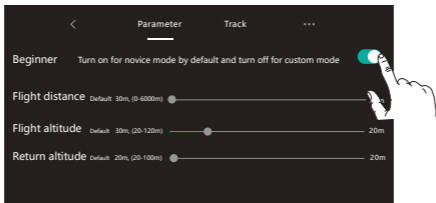



## 3.2 APP Functions >>

### GPS Follow

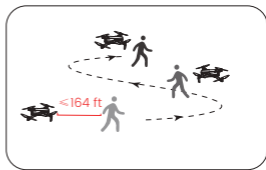
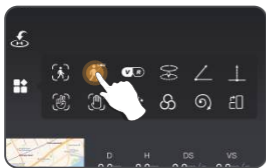
When the GPS Follow function is enabled, the drone will track your movement by following the GPS signal on your cell-phone. (Please make sure that the connection between the drone and the transmitter is strong and stable.)







- 1 Make sure that the drone's flight distance is within 164 ft. Tap the (  ) icon first, then select the (  ) icon.
- 2 Follow the prompt box to enter the GPS Follow function — the drone will now follow your cellphone's coordinates.
- 3 To exit GPS Follow function, simply tap the (  ) icon on the app interface again.

- ⚠ · The GPS Follow function can only be used if the flight distance is within 164 ft.
- Follow Me function may be difficult to activate if the mobile phone's GPS signal is too weak. This could be caused by signal interference from surrounding buildings, trees, mobile network congestion etc.
- Please use this function in an open area and be mindful of your surroundings. The drone is NOT equipped with obstacle avoidance.
- The follow speed is 16.4 ft/s.

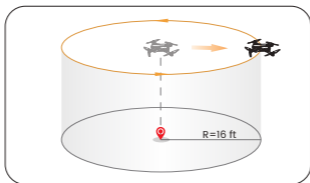
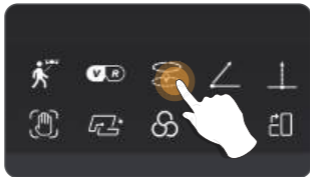
## 3.2 APP Functions &gt;&gt;

## Point of Interest





- 1 Tap the (  ) icon first, then select the (  ) icon, and follow the prompt box to activate the Point of Interest function. You can set the circling radius in the prompt box.
- 2 The moment you activate this function, the drone will record its current flight position as the "point of interest". It will then continuously circle around that point clockwise. (default radius: 16 ft)
- 3 To exit Point of Interest mode, simply tap the (  ) icon again.

## 3.2 APP Functions &gt;&gt;

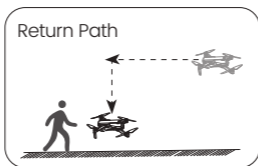
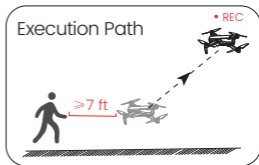
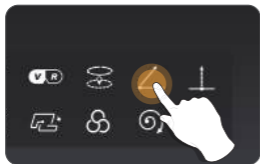
## Catapult







- 1 Make sure that the drone is a least 7 ft away from the target. Adjust the camera angle so it points directly to the target.
- 2 Tap the (  ) icon, then tap (  ). Swipe in the prompt box to confirm.
- 3 The drone will automatically start recording, while flying about 82 ft away from the target.
- 4 After this, it will fly back to the starting point.
- 5 Tap the (  ) icon again, or push the right joystick to exit this function.

- !** Make sure there is no obstacles or people in the flight path of the drone. In case of emergency, push the right joystick to exit Catapult.

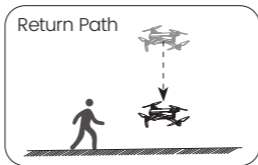
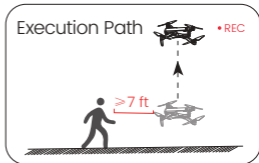
## 3.2 APP Functions >>

### One-key Ascension



- 1 Please make sure that the drone is at least 7 ft away from the target. Adjust the camera angle so it points directly to the target.
- 2 Tap the (  ) icon, then tap (  ) . Swipe in the prompt box to confirm.
- 3 The drone will start recording and climb 49 ft upwards.
- 4 After this, the drone will fly back to the starting point.
- 5 Tap the (  ) icon again, or push the right joystick to exit this function.



- !** Make sure there are no obstacles or people in the flight path of the drone. In case of an emergency, push the right joystick to exit One-key Ascension.

## 3.2 APP Functions >>

### TapFly

Before using TapFly, pre-load the map by connecting your phone to the internet and tapping the map icon; auto-loading occurs. Enlarging the map for TapFly is advised.





- 1 Tap the (  ) icon, then Tap (  ).
  - 2 You can tap a dozen of times (but no more than 16) on the phone screen to create a flight path. Hit "GO" to submit the route. The drone will then fly along the path created by connecting the points you tap in order.
  - 3 You can exit TapFly by tapping the (  ) icon again, or pushing the right joystick in any direction.
- ⚠ DO NOT** fly the drone towards people, animals, or small/thin objects (e.g. tree branches and power lines) or transparent objects (e.g. glass or water).

## 3.2 APP Functions >>

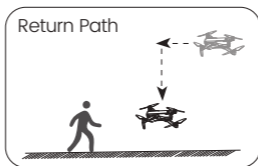
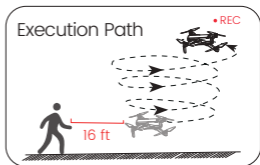
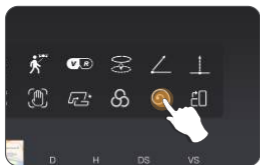
### Spiral Up







- 1 Make sure that the drone is about 16 ft away from the target. Adjust the camera angle so it points directly to the target.
- 2 Tap the (  ) icon, then tap (  ). Swipe in the prompt box to confirm.
- 3 The drone will automatically ascend and circle around (max. radius: about 49 ft) and start recording.
- 4 After this, it will fly back to the starting point.
- 5 Tap the (  ) icon again, or push the right joystick to exit this function.

**!** Make sure there is no obstacles or people in the flight path of the drone. In case of emergency, push the right joystick to exit Spiral Up.

## 3.2 APP Functions >>





### Time-lapse



- 1 Tap the (  ) icon, then tap (  ) to use time-lapse shooting.
- 2 Swipe to choose the video playback speed, tap again to confirm.
- 3 Tap the shutter (  ), the time-lapse shooting begins.
- 4 Tap the shutter (  ) again to stop recording.

### Slow Motion





- 1 Tap the (  ) icon, then tap (  ) to use slow motion shooting.
- 2 Swipe to choose the video playback speed, tap again to confirm.
- 3 Tap the shutter (  ), the slow motion shooting begins.
- 4 Tap the shutter (  ) again to stop recording.

## 3.2 APP Functions &gt;&gt;

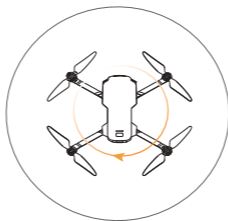
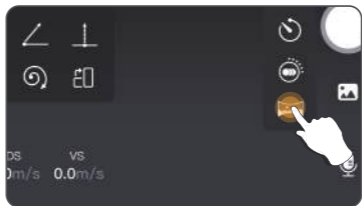
## Panorama



- 1 Tap the (  ) icon, then tap (  ) to use the Panorama function.
- 2 Tap the shutter (  ).
- 3 The drone will maintain its current position and rotate. A panorama picture is then auto-generated and saved to the album. A prompt box will pop up when this is done.

### 3.3 Stabilization Function >>

#### Optical Flow Positioning

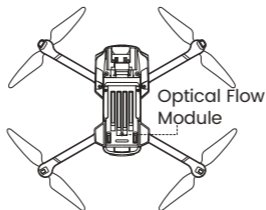

The Optical Flow Positioning System consists of a camera module, which acquires the position information of the drone through visual images to ensure precise positioning of the drone.

---



The Optical Flow Positioning System is typically used in an indoor environment when the GPS signal is weak or unavailable. The optimal usage height for Optical Flow Mode is **1.6–9.8 ft**.

- The precision of the Optical Flow Positioning System is easily affected by the light intensity and features of the surface textures. Once the image sensor is not available, your drone will switch on the altitude-hold function automatically. Please exercise utmost caution when operating the drone under these circumstances:

## 3.3 Stabilization Function >>

### Optical Flow Positioning

- Fly over surfaces without clear patterns or textures.
- Fly over extremely dark or bright surfaces.
- Fly in an area where the lighting changes dramatically and frequently.
- Fly over moving surfaces or objects. (e.g., above crowds, above bushes or grasses swayed by strong winds).
- Fly over water or transparent surfaces.
- Fly over highly light reflective surfaces. (e.g., mirrors).
- Fly over monochrome surfaces (e.g. pure black, red, or green).
- Flying over surfaces with repeating identical patterns or textures (e.g tiles with the same design).
- Flying speed should be controlled not to be too fast.
- Keep sensors clean at all times.
- DO NOT scratch or tamper with the sensors. DO NOT use the aircraft in dusty or humid environments.
- Make sure that the light is bright enough and the surface is with clear textures so that the Optical Flow Positioning can acquire the movement information through recognizing the ground textures.

### Altitude-Hold Function



The drone is designed with an altitude-hold function to maintain its altitude after releasing the left joystick. (The left joystick will automatically spring back to the middle)

## 4.1 Specifications >>

### • DRONE:

Model: HS360D	Weight: 249 g/8.78 oz
Max Flight Time (per battery) : 40 minutes (in a windless environment)	
Max Flight Speed: 22.97 ft/s	Max Flight Height: 394 ft/120m
Max Takeoff Altitude: 9842 ft/3000m	Max Wind Speed Resistance: 18.04 ft/s
Operating Temperature Range: 32° to 104°F (0° to 40°C)	
Size: 140*90*55 mm (folded)	210*180*55 mm (unfolded)

### • DRONE BATTERY:

Model: DS854085-2S	Capacity: 2500 mAh
Voltage: 7.4 V	Max Charging Voltage: 8.9 V
Battery Type: Lithium-ion Polymer Battery	Rated Power: 18.5 Wh
Charging Temperature Range: 41° to 104°F (5° to 40°C)	Charging Time: about 3 hours

### • TRANSMITTER:

Operating Frequency: 5745-5825 MHz	Charging Time: about 110 minutes
Max Flight Distance: 19685 ft/6000 m (outdoor and unobstructed)	Usage Time: about 2.5 hours
Operating Temperature Range: 32° to 104°F (0° to 40°C)	
Battery Type: 7.4V 1100mAh Lithium-ion Polymer Battery	

## 4.1 Specifications >>

### • USB CHARGING CABLE:

Input: 5V/3A

Rated Power: ≤15 W

### • CAMERA:

Operating Frequency: 5745-5825 MHz

Max Transmission Distance: 19685 ft/6000 m (outdoor and unobstructed)

Photo Resolution: 4000×3000P  
(when stored in TF card)

3840×2160P  
(when stored in cellphone)

Video Resolution: 3840×2160P@20fps  
(when stored in TF card)

1280×720P@30fps  
(when stored in cellphone)

Controllable Range: -90° to 0°

Supported File Systems: FAT32

Supported TF Cards: Supports a TF Card with capacity of up to 256 GB  
(Class 10 or above)

Photo Formats: JPEG

Video Formats: MP4

## 4.2 Contact Information >>

Please do not hesitate to contact us if you need further support.



usa@holystone.com (America)    ca@holystone.com (Canada)  
eu@holystone.com (Europe)    au@holystone.com (Australia)



+1 (833) 766-4733

## 4.3 Troubleshooting >>

Issue	Possible Causes	Suggested Solutions
Motors won't start.	Weak GPS signal.	<ol style="list-style-type: none"> <li>1. Ensure you're operating in an area with strong GPS reception.</li> <li>2. For indoor operations, long-press the button to transition to Altitude-hold Function. (See Page 24 in the user manual)</li> </ol>
	The drone's battery is running low (as indicated by a continuous red light on the drone).	Recharge the battery.
	The compass isn't calibrated (evidenced by the continuous flashing of red and blue lights on the drone's underside)	Conduct a compass calibration. For step-by-step instructions, refer to the "Compass Calibration" section in the user manual. (See Page 21 in the user manual)
	The left and right joysticks were not properly positioned during the unlocking process.	Push both of the joysticks simultaneously toward the inner, lower corners.
Unstable flight or abnormal posture.	GPS signal instability due to flying near buildings or in areas with obstructions.	Operate the drone in open spaces free from obstructions.
	Compass interference	<ol style="list-style-type: none"> <li>1. Manually land the drone immediately and recalibrate the compass.</li> <li>2. Try operating in a different location, ensuring you're away from buildings, power lines, and signal towers.</li> </ol>
	Propeller deformation or damage.	Replace with new propellers.
Video lag or limited transmission range	Interference with the video transmission signal.	Operate the drone in open areas away from potential obstructions like buildings, power lines, and towers to minimize interference.
	The transmitter and mobile device are not oriented towards the drone.	Ensure the transmitter and mobile device are facing the drone's direction to optimize signal strength.
	Overly rapid joystick movements during flight control.	Use gentle, steady joystick movements during flight.
	Phone performance issues.	Close any unused apps running in the background to optimize your phone's performance.

## 4.4 Compliance Information >>

### FCC Notice :

This device complies with part 15 of the FCC Rules. Operation is subject to the following two conditions:

- ( 1 ) This device may not cause harmful interference, and
- ( 2 ) This device must accept any interference received, including interference that may cause undesired operation.

The Supplier's Declaration of Conformity is available at the following address:

[https://www.holystone.com/Download/US/HS360D\\_FCC\\_sDoC.pdf](https://www.holystone.com/Download/US/HS360D_FCC_sDoC.pdf)

This equipment has been tested and found to comply with the limits for a Class B digital device, pursuant to part 15 of the FCC Rules. These limits are designed to provide reasonable protection against harmful interference in a residential installation. This equipment generates, uses and can radiate radio frequency energy and, if not installed and used in accordance with the instructions, may cause harmful interference to radio communications. However, there is no guarantee that interference will not occur in a particular installation. If this equipment does cause harmful interference to radio or television reception, which can be determined by turning the equipment off and on, the user is encouraged to try to correct the interference by one or more of the following measures:

- Reorient or relocate the receiving antenna.
- Increase the separation between the equipment and receiver.
- Connect the equipment into an outlet on a circuit different from that to which the receiver is connected.
- Consult the dealer or an experienced radio/TV technician for help.

Changes or modifications not expressly approved by the party responsible for compliance could void the user's authority to operate the equipment.

### RF Exposure :

The equipment complies with FCC radiation exposure limits set forth for an uncontrolled environment. This device should be installed and operated with minimum distance 20cm between the radiator & your body. This part belongs to the drone.

This equipment complies with FCC/ISED radiation exposure limits set forth for an uncontrolled environment. End user must follow the specific operating instructions for satisfying RF exposure compliance. This transmitter must not be co-located or operating in conjunction with any other antenna or transmitter.

The portable device is designed to meet the requirements for exposure to radio waves established by the FCC/ISED. These requirements set a SAR limit of 1.6 W/kg averaged over one gram of tissue.

## 4.4 Compliance Information >>

### IC Statement :

This device contains licence-exempt transmitter(s)/receiver(s) that comply with Innovation, Science and Economic Development Canada's licence-exempt RSS(s). Operation is subject to the following two conditions:

- (1) This device may not cause interference.
- (2) This device must accept any interference, including interference that may cause undesired operation of the device.

L' émetteur/récepteur exempt de licence contenu dans le présent appareil est conforme aux CNR d' Innovation, Sciences et Développement économique Canada applicables aux appareils radio exempts de licence.

L' exploitation est autorisée aux deux conditions suivantes :

- (1) L' appareil ne doit pas produire de brouillage;
- (2) L' appareil doit accepter tout brouillage radioélectrique subi, même si le brouillage est susceptible d' en compromettre le fonctionnement.

### CAN NMB-003 (B) :

RF Exposure

Radiation Exposure Statement:

This equipment complies with IC radiation exposure limits set forth for an uncontrolled environment. This equipment should be installed and operated with a minimum distance of 20cm between the radiator & your body.

Déclaration d'exposition aux radiations:

Cet équipement est conforme aux limites d'exposition aux rayonnements IC établies pour un environnement non contrôlé. Cet équipement doit être installé et utilisé avec un minimum de 20 cm de distance entre la source de rayonnement et votre corps.

**EU RF Power (EIRP) :** <14 dBm (5745-5825MHz)

### Caution :

The max operating of the EUT is 40°C. and shouldn't be lower than 0°C.

The device complies with RF specifications when the device used at 0mm from your body.

Declaration of Conformity.

We, Xiamen Huoshiquan Import & Export CO., LTD hereby, declare that the UAS HS360D is of class C0, and in compliance with the RED Directive 2014/53/EU, the RoHS Directive 2011/65/EU, Machinery Directive 2006/42/EC and UAS Delegated Regulation 2019/945/EU amended by Delegated Regulation 2020/1058/EU.

The full EU declaration of conformity is accessible at the following website:  
[http://www.holystone.com/Download/CE/HS360D\\_EU\\_DOC.pdf](http://www.holystone.com/Download/CE/HS360D_EU_DOC.pdf)

This product can be used among EU member states.

## 4.4 Compliance Information >>

### Manufacturer Information :

Manufactured by Xiamen Huoshiquan Import & Export CO.,LTD  
Address: Unit 1, Room 501, Hongxiang Building, No.258 Hubin Nan Road,  
Siming District, Xiamen, China  
+1 (833) 766-4733

### MTOM Statement

HS360D is a quadrotor drone. The MTOM of HS360D is 249 g, including the propellers, the Flight Battery and TF card, which is compliant with C0 requirements.

Users must follow the instructions below to comply with the MTOM C0 requirements. Otherwise, the drone cannot be used as a C0 aircraft:

1. DO NOT add any payload to the aircraft except the items listed in the List of Items including qualified accessories section.
2. DO NOT use any non-qualified replacement parts, such as flight batteries or propellers, etc.
3. DO NOT retrofit the aircraft.

### List of Items including qualified accessories

1. HS360D Propellers (HS360D-FY, 1.5 g each propeller, 6600RPM)
2. HS360D Flight Battery (approx. 85 g)
3. HS360D TF card (approx. 0.3 g).

### List of Spare and Replacement Parts

1. HS360D Propellers (1.5 g each propeller)
2. HS360D Flight Battery (approx. 85 g)

### List of Safe Guards

Below is the list of the mechanical safeguards and operation safeguards for HS360D.

1. Emergency Stop function can be performed to stop the motors in case of an emergency. Refer to the Emergency Stop section for details.
2. The Return to Home (RTH) function. Refer to the GPS Return to Home section for details.
3. The Optical Flow Positioning. Refer to the Optical Flow Positioning section for details.
4. Prevent the drone from flying in restricted airspace. Refer to the Flight Environment Requirements section for details.

## 4.4 Compliance Information >>

Similar products produced by the same manufacturer are electrically identical. Distinguish them based on product model and appearance color. The firmware of toy product cannot be upgraded.

In the future, new versions of the app will be released through the app store. Users can update the app by scanning the QR code in the instruction or searching "HS FLY" on the app store.



MADE IN CHINA(CN)



**HOLY  
STONE**

*Dare to fly. Soar to live.*