

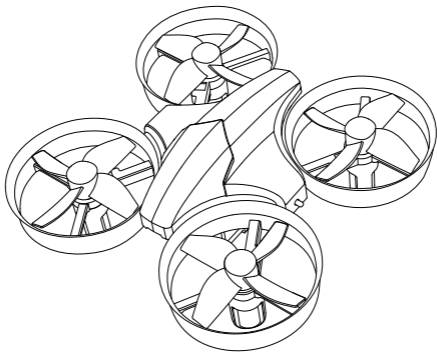



14+
age

Instructions For Use

V6.0



HS210

 +1(855) 888-6699

 www.holystone.com

 usa@holystone.com (USA)
ca@holystone.com (CA)

eu@holystone.com (EU)
jp@holystone.com (JP)

Contents

1.0 Disclaimer & Warning	1
2.0 Safety Guidelines	1
3.0 Maintenance	5
4.0 Packing Contents	6
5.0 Drone Details	7
6.0 Low Battery Warning	7
7.0 Transmitter Functions	8
8.0 Joystick Mode	9
9.0 Installation	10
10.0 Charging	11
11.0 Flight	
Pairing	12
Calibrate the Gyro	13
Auto Takeoff	14
One Key Landing	15
12.0 Functions Details	
Altitude-Hold Function.....	15
Trimmer	16
Speed Switch	17
Emergency Stop	17
360 ° Flip	18
Circle Fly	19
Auto-Rotation	19
Headless Mode	20
13.0 Specification	21
14.0 Contact Us	22
15.0 General Information	23

1.0 DISCLAIMER & WARNING

1. Please read this Disclaimer & Warning and Safety Guidelines carefully before using our product. This product is not recommended for people under the age of 14. By using this product, you hereby agree to this disclaimer and signify that you have read it fully. You agree that you are responsible for your own conduct and any damages caused while using this product, and its consequences. You agree to only use this product for its designed purposes and in accordance with local laws, regulations and all applicable policies and guidelines that HolyStone may provide.

2. When using this product, please be sure to strictly abide by the specification requirements and safety guidelines stated in this document. Any personal injury, property damage, legal disputes and all other adverse events caused by the violation of any of the safety instructions or due to any other factor, WILL NOT be HolyStone's responsibility.

2.0 SAFETY GUIDELINES

2.1 Check Before Use

- ① This product is a high precision drone that integrates various electronic stability and control mechanisms. Please be sure to configure this drone carefully and correctly to ensure safe, accident-free operation.
- ② Ensure that the batteries of the drone and transmitter are clean, undamaged and fully charged before every use.
- ③ Ensure that all the propellers are undamaged and are installed in the correct orientation.

④ Ensure to do a thorough check of the product before each use. Inspect the integrity of the parts, any signs of cracks and wear of the propeller, battery power and effectiveness of the indicator, etc. If after doing a complete check of the drone any problems are found, please refrain from using it until the problem has been resolved.

2.2 Flight Environment



+



+



Fly in Open Areas

Maintain Line of Sight

**Fly Below
164 feet (50 m)**



Avoid flying over or near obstacles, crowds, high voltage power lines, trees, airports or bodies of water.

DO NOT fly near strong electromagnetic sources such as power lines and base stations as it may affect the onboard compass.



DO NOT use this drone in adverse weather conditions such as rain, snow, fog, and wind.

2.3 Operation Requirements

- ① DO NOT use this product to follow any moving vehicles.
- ② During the flight, turn off the motors only in case of an emergency.
- ③ Fly the drone back to you as soon as you are notified that the battery is running low.
- ④ This product should not be used while drinking alcohol or consuming drugs, if you are feeling fatigued, taking medicine, or feeling any physical discomfort.
- ⑤ Be aware of the volume of noise that the drone produces. Please ensure to keep your distance to avoid ear damage.



- ⑥ **Stay away from the rotating propellers and motors.**



- ⑦ **DO NOT fly in any spaces where drones are prohibited. Please respect people's right to privacy by not flying your drone close to others.**

2.4 Use of Battery

- ① Please ensure batteries are fitted in the correct orientation as shown in the instruction manual.
- ② Avoid short circuits by fitting the batteries correctly, and do not crush or squeeze the batteries as this could cause the risk of a fire or explosion.
- ③ DO NOT mix new and old batteries as this can lead to a poor performance of the product.
- ④ Please dispose of used batteries carefully, do not litter and recycle where ever possible.
- ⑤ DO NOT expose dead batteries to heat or fire or they may explode.
- ⑥ If the device is not going to be used for an extended period of time,

please remove batteries to prevent potential damage from to the drone battery leakage.

- ⑦ Only use the USB charging cable that comes with the drone to charge the battery.
- ⑧ DO NOT connect the battery directly to wall outlets or car cigarette -lighter sockets as this will damage your battery as they are a different voltage.
- ⑨ DO NOT attempt to disassemble or modify the battery in any way
- ⑩ DO NOT use the battery if it gives off an odor, generates heat, becomes discolored, deformed or appears abnormal in any way. If any of these situations occur while the battery is in use or being charged, remove it from the device or charger immediately and discontinue use.
- ⑪ DO NOT pierce the battery casing with a nail or any other sharp object, break it open with a hammer, or step on it! Dispose or recycle this battery as it may cause personal injury or damage to your drone.
- ⑫ Always charge the batteries on a fireproof surface and away from combustible materials. DO NOT charge on surfaces that can catch fire. This includes: wood, cloth, carpet, or on the application's device.
- ⑬ DO NOT immerse the battery in water or get it wet.
- ⑭ DO NOT solder battery terminal in any way.
- ⑮ Keep batteries out of reach of children or pets.
- ⑯ DO NOT short-circuit the battery by connecting wires or any other metal object to the positive(+) and negative(-) terminals.



Li-Po Battery Disposal & Recycling









Waste Lithium-polymer batteries must not be placed with household trash. Please contact local environmental or waste agency or the waste agency or the supplier of your model or your nearest Li-Po battery recycling center.



3.0 MAINTENANCE

- ① Clean the product after each use with a clean, soft cloth.
- ② Avoid prolonged exposure to direct sunlight and avoid buildup of heat on the drone or batteries.
- ③ This device is not waterproof and must not be submerged or subjected in water under any circumstance. Failure to keep the device completely dry will result in the failure and permanent damage to the unit. Be aware that although it might be dry where you are, droplets of rain or mist from a river or waterfall could be damaging your drone where it is flying.
- ④ Frequently Check the charging plug and other accessories for signs of damage. If any part of the device or cables are damaged, avoid use or charging until the device can be serviced.

4.0 PACKAGE CONTENTS

		
Drone	Transmitter	Drone Battery
		
USB Charger	Spare Propellers	Screwdriver
		
Propellers Spanner	Instructions For Use	

5.0 DRONE DETAILS

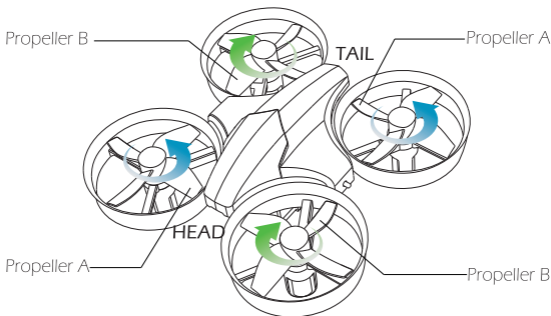

6.0 LOW BATTERY WARNING

① When the drone battery runs low, the indicator lights on the drone will blink continuously. About 1 minute or so the drone will automatically land on low electricity.

② When the transmitter battery runs low, the power indicator of the transmitter will blink continuously and the transmitter will keep beeping. When this happens, the pilot should change the new battery for the transmitter.

7.0 TRANSMITTER FUNCTIONS

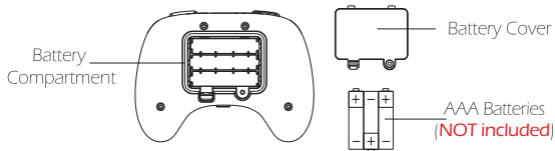
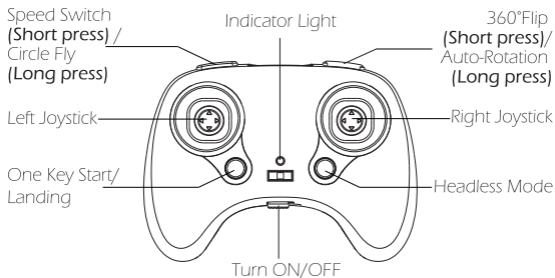

If you want to install the batteries, please always pay close attention to battery polarity to make sure they are inserted correctly.

8.0 JOYSTICK MODE

8.1 MODE 2 (Default Setting)

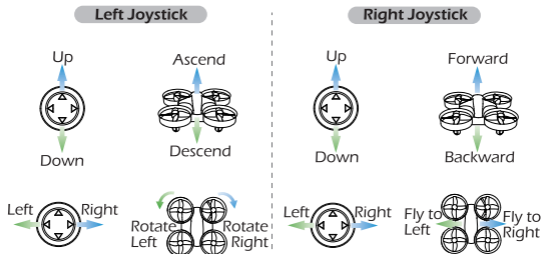

8.2 MODE 1

To enter MODE 1, turn on the transmitter while holding the “Speed Switch” button. (Please do not release the “Speed Switch” button until the transmitter is powered on.)

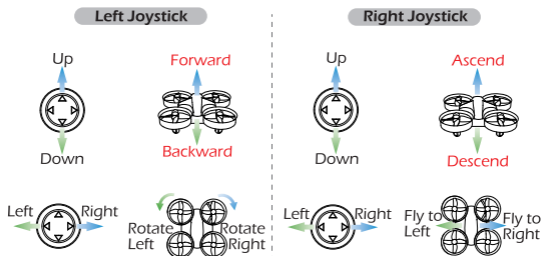

9.0 INSTALLATION

9.1 Propeller

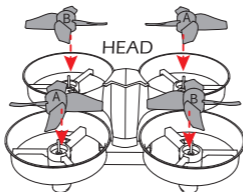

See illustration above. An “A” or “B” is printed on each propeller. Install the propeller to the motor shaft and press into place.

Attention: The drone will not fly unless the correct propeller is installed on the correct motor shaft.

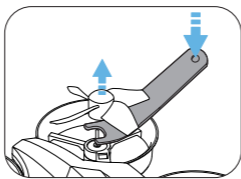

Removal: Insert the propeller spanner between the propeller and the motor. Be sure to hold the motor while detaching the propeller.

10.0 CHARGING

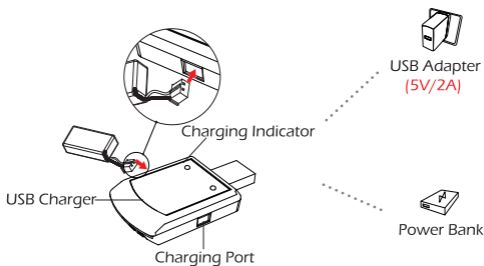

- ① Connect the battery with the charger.
- ② Plug the charger into a USB charging port on power bank or USB adapter (5V/2A).
- ③ Charging time: about 40-60 minutes.
- ④ a. While the battery is charging, the charging indicator light is Red.
b. When the battery is full charged, the charging indicator light will turn Green.



Before charging, please check the contents of the "Use of Battery" section of the "Safety Guidelines" carefully!

11.0 OPERATION GUIDE

All of the operations shown in this manual are demonstrated using **MODE 2**.

11.1 Pairing

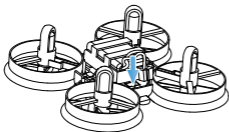

① Connect the battery port access to the fuselage power port.

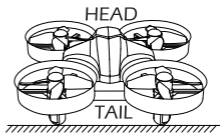

② Place the drone on a flat and level surface with the head forward and the tail towards the pilot.

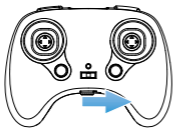

③ Turn on the transmitter.



④ Push the throttle joystick up then down to pair the drone with the transmitter. The LED indicator lights on the drone will turn solid if the drone is paired successfully.

11.2 Calibrate the Gyro

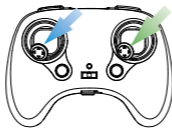

As shown in the diagram above, push the left and right joystick simultaneously to the lower left corner to calibrate the gyro. The indicator lights on the drone will blink quickly and turn solid. When you hear 2 beeps from the transmitter that indicates the calibration is completed.

Tip: To ensure a stable flight, we suggest that the pilot calibrates the gyro every time after pairing the drone and after a crash.

11.3 Auto Takeoff

There are two methods to take off the drone.



Method 1: Press the One Key Start button, the propellers will start spinning, indicating this drone is ready to fly. Then push the left joystick up slowly to take off. The more the joystick is pushed away from the center position, the faster the drone will change elevation. Always push the joystick gently to prevent sudden and unexpected elevation changes.



Method 2: After pairing, pick up the drone and lay it flat on your palm. Gently toss the drone into air, and it will hover in place.

11.4 One Key Landing

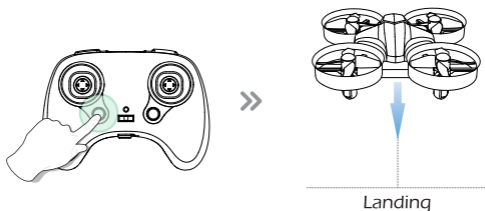

When in flight, you can press the One Key Landing button, the drone will land automatically.

12.0 FUNCTIONS DETAILS

12.1 Altitude-Hold Function

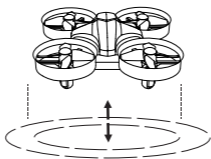

The drone is designed with altitude-hold function so the drone can maintain its altitude after you release the left joystick (the left joystick will automatically spring back to the middle).

12.2 Trimmer

F/B Sideward Fly Trim

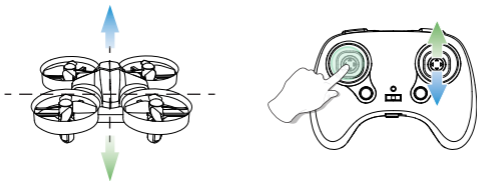

If the drone drifts forward, hold down the throttle joystick and do not release it while pushing the direction joystick down to balance the drone; If the drone drifts backwards, hold down the throttle joystick and do not release it while pushing the direction joystick up to balance the drone.

L/R Sideward Fly Trim

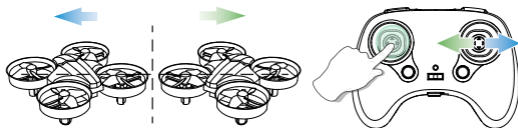

If the drone drifts left, hold down the throttle joystick and do not release it while pushing the direction joystick right to balance the drone; If the drone drifts right, hold down the throttle joystick and do not release it while pushing the direction joystick left to balance the drone.

(When you hear one long beep from the transmitter that indicates the drone is adjusted to balance.)

12.3 Speed Switch

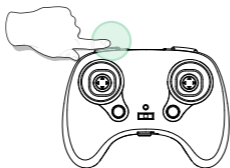

This drone comes with 3 speed modes (Low/ Medium/ High). Press the Speed Switch button on the upper left of the transmitter to switch the speed. Increase or decrease one speed at a time.

“Di” indicates Low speed, “DiDi” indicates Medium speed and “DiDiDi” indicates High speed. (The Low Speed is default speed mode.)

12.4 Emergency Stop

 The Emergency Stop function can be only used in case of emergency during the flight to avoid any of damage or injury.



Press the upper left and upper right button of the transmitter at the same time, the motors will stop immediately.

12.5 360° Flip

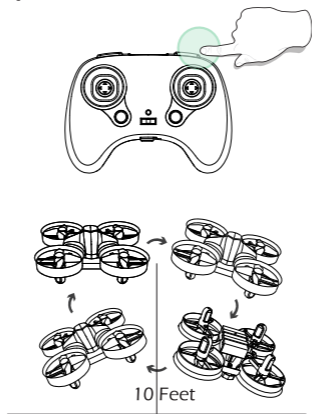

When you get familiar with all the functions of the drone, you can try this amazing flip mode. When you fly the drone at least 10 feet, press the 360° Flip button on the upper right of the transmitter, then push the right joystick Forward/ Backward or Left/ Right, and the drone will do a flip towards the corresponding direction.

If you are in MODE 1, push the right joystick Left/ Right or push the left joystick Forward/ Backward, and the drone will do a flip towards the corresponding direction.

Tip: This function will perform better when the battery is fully charged.

12.6 Circle Fly

Long press for 3 seconds

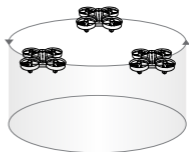
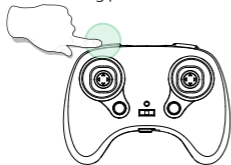

Press and hold the Speed Switch button for about 3 seconds, the drone will enter the Circle Fly mode. Exit the Circle Fly mode by long pressing the same button again or pushing the direction joystick.

12.7 Auto-Rotating

Long press for 3 seconds

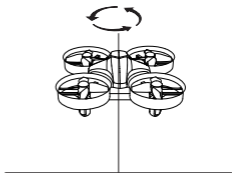
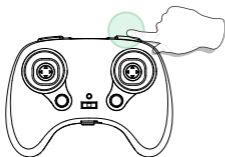

Press and hold the Flip button for about 3 seconds, the drone will enter the Auto-Rotation mode. Exit the Auto-Rotation mode by long pressing the same button again or pushing the direction joystick.

12.8 Headless Mode

1. After pairing/calibration, press the Headless Mode button on the transmitter. A beep will be heard from the transmitter, and the lights on the drone will keep blinking. The transmitter will beep slowly to indicate that drone is in Headless Mode.

2. Press the Headless Mode button again, and you will hear 2 beeps, the LED indicator lights on the drone will be solid which indicates the drone exits the Headless Mode.

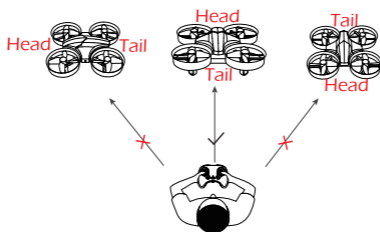

Please make the pilot stays facing the same direction as the direction that the head of the drone faces at take-off.

Under Headless Mode, the forward direction is the direction that the head of drone faces when the drone takes off. In order to make sure the pilot can tell drone's direction, we recommend that pilots to stay in the same orientation as the drone head faces when the drone takes off. If so, when the pilot pushes the direction joystick forward, the drone will fly forward. If the pilot pushes the direction joystick backward, the drone will fly towards him/her. If the pilot moves the right stick left / right, the drone will move left/ right relative to you. It is very important that the pilot stays in the same orientation as the drone head faces when the drone takes off.

13.0 SPECIFICATIONS

DRONE

Model: HS210

Weight: 22g/0.77oz

Max Flight Time: 7 minutes (per battery)

Motor Model: 0615

Operating Temperature Range: 14°F to +104°F (-10°C to +40°C)

Size: 80 x 80 x 30 mm

FLIGHT BATTERY

Capacity: 250mAh

Voltage: 3.7V

Battery Type: Lithium-ion polymer Battery

Charging Temperature Range: 41° to 104°F (5° to 40°C)

Charging Time: 40 - 60 minutes (depends on charging power and remaining battery power)

TRANSMITTER

Operating Frequency: 2452-2474 MHz

Max Flight Distance: 50 m (outdoors and unobstructed)

Operating Temperature Range: 32° to 104°F (0° to 40°C)

Battery Type: 1.5V AAA Battery (Not included)

USB CHARGING CABLE

Input: 5 V/2A

Rated Power: ≤10 W

14.0 CONTACT US

Please do not hesitate to contact us if you need further support.

 4:00 PM ~ 7:00 AM (PST)

 usa@holystone.com (USA)
ca@holystone.com (CA)
eu@holystone.com (EU)
jp@holystone.com (JP)

 +1(855) 888-6699



For online support, please scan
this code with Live Chat

15.0 GENERAL INFORMATION

FCC Notice:

This device complies with Part 15 of the FCC Rules.

Operation is subject to the following two conditions:

- (1) This device may not cause harmful interference, and
- (2) This device must accept any interference received, including interference that may cause undesired operation.

The Supplier's Declaration of Conformity is available at the following address:

https://www.holystone.com/Download/US/HS210_FCC_sDoC.pdf

NOTE: This equipment has been tested and found to comply with the limits for a Class B digital device, pursuant to Part 15 of the FCC Rules. These limits are designed to provide reasonable protection against harmful interference in a residential installation. This equipment generates uses and can radiate radio frequency energy and, if not installed and used in accordance with the instructions, may cause harmful interference to radio communications. However, there is no guarantee that interference will not occur in a particular installation. If this equipment does cause harmful interference to radio or television reception, which can be determined by turning the equipment off and on, the user is encouraged to try to correct the interference by one or more of the following measures:

- Reorient or relocate the receiving antenna.
- Increase the separation between the equipment and receiver.
- Connect the equipment into an outlet on a circuit different from that to which the receiver is connected.
- Consult the dealer or an experienced radio/TV technician for help.

WARNING: Changes or modifications not expressly approved by the party responsible for compliance could void the user's authority to operate the equipment.

RF Exposure

The equipment complies with FCC radiation exposure limits set forth for an uncontrolled environment. This device should be installed and operated with minimum distance 20cm between the radiator & your body.

IC Notice:

This device complies with Canada Industry licence-exempt RSS standard (s).

Operation is subject to the following two conditions:

- (1) this device may not cause interference; and
- (2) this device must accept any interference. Including interference that may cause undesired operation of the device.

CAN ICES-003 (B)

Avis d'Industrie Canada

Le présent appareil est conforme aux CNR d'industrie Canada applicables aux appareils radio exem pts de licence L'exploitation est autorisée aux deux conditions suivantes:

- 1) l'appareil ne doit pas produire de brouillage; et
- 2) l'utilisateur de l'appareil doit accepter brouillage radioélectrique subi même si le brouillage est susceptible d'encompromettre le fonctionnement. mauvais fonctionnement de l'appareil. Cet appareil numérique de la classe B est conforme à la norme NMB-003 du Canada.

CAN NMB-003 (B)

RF Exposure

Radiation Exposure Statement:

This equipment complies with IC radiation exposure limits set forth for an uncontrolled environment. This equipment should be installed and operated with a minimum distance of 20cm between the radiator & your body.

Déclaration d'exposition aux radiations:

Cet équipement est conforme aux limites d'exposition aux rayonnements IC établies pour un environnement non contrôlé. Cet équipement doit être installé et utilisé avec un minimum de 20 cm de distance entre la source de rayonnement et votre corps.

HOW TO RECYCLE THIS PRODUCT

This symbol on the product or its documentation indicates that it **MUST** not be disposed of together with household waste.

Uncontrolled waste disposal may harm the environment or human health.

Please separate your device from other types of waste for recycling it responsibly.

This will help to foster the sustainable re-use of material resources.

We suggest you contact your retailer, inquire at your local town hall or business store to find out where and how the drone can be recycled.



BATTERY WARNING:

1. Failure to follow all the instructions may result in serious injury, irreparable damage to the battery may cause a fire, smoke or explosion as well.
2. Always check the battery's condition before charging or using it.
3. Please replace the battery if the battery is dropped or has any peculiar smell, overheating, discolouration, deformation or leakage happens.
4. Never use anything other than the approved LiPo charger to charge the battery. Always use a balancing charger for LiPo cells or a LiPo cell balancer. It is recommended that you use the one provided with the product.
5. The battery temperature must never exceed 60°C(140°F) otherwise the battery could be damaged or ignited.
6. Never charge the battery on a flammable surface, near flammable products or inside a vehicle(preferably place the battery on a non-flammable and non-conductive surface).
7. Never leave the battery unattended during the charging process. Never disassemble or modify the housing's wiring, or puncture the cells. Always ensure that the charger output voltage corresponds to the voltage of the battery. DO NOT short circuit the batteries.
8. Never expose the Li-Po battery to moisture or direct sunlight, or store it in a place where temperatures could exceed 60°C(car in the sun, for example).
9. Always keep it out of reach of children.
10. Improper battery use may result in a fire, explosion or other hazards.

11. Non-rechargeable batteries are not allowed to be recharged. Rechargeable batteries should be charged under adults' supervision.

12. DO NOT mix different types of batteries including the new and used ones.

13. Batteries MUST be inserted with the correct polarity.

14. The supply terminals MUST not to be short-circuited. Regular examination of transformer or battery charger for any damage to their cords, plugs, enclosures and other parts MUST be done. If there is damage, they MUST not be used until the damage has been repaired.

15. The packaging has to be kept since it contains important information.

16. This toy is only can be connected to the equipment with symbol Class II. 

EU RF Power(EIRP): <10 dBm (2452-2474 MHz)

Caution

1.The max operating of the EUT is 45°C, and shouldn't be lower than -10°C.

2.The device complies with RF specifications when the device used at 0mm form your body.

3.Declaration of Conformity.

We, Xiamen Huoshiquan Import & Export CO.,LTD
hereby, declare that the compliance of the essential requirements with
the

Directive 2014/53/EU, the RoHS Directive 2011/65/EU and Safety
Directive 2009/48/EC have been fully fulfilled on our product with
indication below:

Product Name: Remote control four axis series

Model/Mark : HS210/HOLYSTONE

The Statement of compliance is available at the following address:

http://www.holystone.com/Download/CE/HS210_EU_DOC.pdf

This product can be used among EU member states.

MANUFACTURER INFORMATION

Manufactured by

Xiamen Huoshiquan Import & Export CO.,LTD.

Unit 1, Room 501, Hongxiang Building, No.258 Hubin Nan Road,
Siming District, Xiamen, China

+1(855) 888-6699



MADE IN CHINA(CN)

