

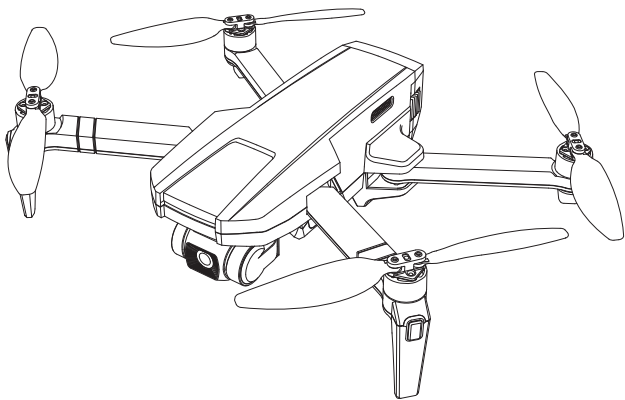



16+
age

Instructions For Use Gebrauchsanweisung

V1.0



HS720R

 +1(855) 888-6699

 www.holystone.com

 usa@holystone.com (USA) eu@holystone.com (EU)
ca@holystone.com (CA)

English

01-47

Deutsch

48-91

Contents

1.0 Disclaimer & Warning.....	01
2.0 Safety Guidelines.....	01
3.0 Maintenance.....	05
4.0 FAA Flight Regulations.....	05
5.0 Package Contents.....	06
6.0 Drone Details.....	07
7.0 Transmitter Details	
7.1 Transmitter Functions.....	08
7.2 Joystick Mode.....	10
8.0 Charging	11
9.0 Preparation Before Flight	
9.1 Download APP	12
9.2 Arms.....	12
9.3 Gimbal Cover.....	13
9.4 TF Card.....	13
9.5 Drone Battery.....	14
9.6 Propellers.....	15
9.7 Antenna.....	16
9.8 Foldable Handle.....	17
9.9 Phone Holder.....	17
10.0 Flight	
10.1 Pairing.....	18
10.2 Initialization Detection.....	19
10.3 Connect to Wi-Fi.....	19
10.4 Calibrating the Compass.....	20
10.5 Unlocking the Motors.....	21
10.6 One Key Takeoff/Landing.....	22

11.0 Return to Home	
11.1 Smart RTH.....	23
11.2 Failsafe RTH.....	23
11.3 The First Stage of Low Voltage RTH.....	24
11.4 The Second Stage of Low Voltage RTH.....	25
12.0 APP Operation Instruction	
12.1 Operation Interface.....	27
12.2 Beginner Mode.....	29
12.3 Follow Me.....	30
12.4 Point of Interest.....	31
12.5 Take Photo/Record Video	31
12.6 Time-Lapse	32
12.7 TapFly.....	33
13.0 Stabilization Function	
13.1 Altitude-Hold Function.....	35
13.2 Optical Flow Positioning.....	35
14.0 Status Indicator States	37
15.0 Specifications.....	39
16.0 Contact Us.....	41
17.0 General Information.....	42

1.0 DISCLAIMER & WARNING

1. Please read this Disclaimer & Warning and Safety Guidelines carefully before using our product. This product is not recommended for people under the age of 16. By using this product, you hereby agree to this disclaimer and signify that you have read it fully. You agree that you are responsible for your own conduct and any damage caused while using this product, and any consequence. You agree to only use this product for its designed purposes and in accordance with the local laws, regulations and all applicable policies and guidelines that HolyStone may provide.

2. When using this product, please be sure to strictly abide by the specification requirements and safety guidelines stated in this document. Any personal injury, property damage, legal disputes and all other adverse events caused by the violation of any of the safety instructions or due to any other factor, WILL NOT be HolyStone's responsibility.

2.0 SAFETY GUIDELINES

2.1 Check Before Use

- ① This product is a high precision drone that integrates various electronic stability and control mechanisms. Please be sure to configure this drone carefully and correctly to ensure safe, accident-free operation.
- ② Ensure that the batteries of the drone and transmitter are clean, undamaged, and fully charged before every use.
- ③ Ensure that all the propellers are undamaged and are installed in the correct orientation.

④ Please perform a thorough check of the product before each use. Inspect the integrity of the parts, any signs of cracks and wear off on the propellers, battery power and effectiveness of the indicator, etc. If there is any problem found after checking the drone, please refrain from using it until the problem is resolved.

2.2 Flight Environment



+



+



Fly in Open Areas

**Maintain Line
of Sight**

**Fly Below
394 feet (120 m)**



Avoid flying over or near obstacles, crowds, high voltage power lines, trees, airports or bodies of water.

DO NOT fly near strong electromagnetic sources such as power lines and base stations as it may affect the onboard compass.



DO NOT use this drone in adverse weather conditions such as rain, snow, fog, and wind.

2.3 Operation Requirements

- ① DO NOT use this product to follow any moving vehicles.
- ② During the flight, turn off the motors only in case of an emergency.
- ③ When the battery runs low, return the drone back to your starting point.
- ④ DO NOT use this product if you feel unwell, tired, or are under the influence of alcohol or drugs
- ⑤ Be aware of the volume of noise that the drone produces. Please ensure to keep your distance to avoid ear damage.



⑥ **Stay away from the rotating propellers and motors.**

⑦ **DO NOT fly in any spaces where drones are prohibited. Please respect people's right to privacy by not flying your drone close to others.**

2.4 Use of Battery

- ① Please ensure batteries are fitted in the correct orientation as shown in the instruction manual.
- ② Avoid short circuits by fitting the batteries correctly, and do not crush or squeeze the batteries as this could cause the risk of a fire or explosion.
- ③ DO NOT mix new and old batteries as this can lead to poor performance of the product.
- ④ Please dispose of used batteries carefully, do not litter, and recycle where ever possible.
- ⑤ DO NOT expose the batteries to heat or fire as this may result in an explosion.

- ⑧ If the device is not going to be used for an extended period of time, please remove batteries to prevent potential damage to the drone from battery leakage.
- ⑦ Only use the USB charging cable that comes with the drone to charge the battery.
- ⑧ DO NOT connect the battery directly to wall outlets or car cigarette-lighter sockets as their voltages are different, and the battery can thus be damaged.
- ⑨ DO NOT attempt to disassemble or modify the battery in any way.
- ⑩ DO NOT use the battery if it gives off an odor, generates heat, becomes discolored, deformed or appears abnormal in any way. If any of these situations occurs while the battery is in use or being charged, remove it from the device or charger immediately and discontinue its use.
- ⑪ DO NOT pierce the battery casing with a nail or any other sharp object, break it open with a hammer, or step on it! Dispose or recycle the damaged battery as it may cause personal injury or damage to your drone.
- ⑫ Always charge the batteries on a fireproof surface and away from combustible materials. DO NOT charge on surfaces that can catch fire, which includes but not limited to wood, cloth, plastic and carpets..
- ⑬ DO NOT immerse the battery in water or get it wet.
- ⑭ DO NOT solder battery terminal in any way.
- ⑮ Keep batteries out of reach of children or pets.
- ⑯ DO NOT short-circuit the battery by connecting wires or any other metal object to the positive (+) and negative (-) terminals.



Li-Po Battery Disposal & Recycling

Waste Lithium-polymer batteries must not be placed with household trash. Please contact local environmental or waste agency or the waste agency or the supplier of your model or your nearest Li-Po battery recycling center.







3.0 MAINTENANCE

- ① Clean the drone after each use with a clean, soft cloth.
- ② Avoid prolonged exposure to direct sunlight and avoid buildup of heat on the drone or batteries.
- ③ This device is not waterproof. DO NOT allow it to get wet or submerged in water. Failure to keep the device completely dry will result in the failure and permanent damage to the unit. Be aware that although it might be dry where you are, droplets of rain or mist from a river or waterfall could damage your drone while it is flying.
- ④ Frequently check the charging plug and other accessories for signs of damage. If any part of the device or cables are damaged, avoid use or charging until the damaged part is replaced.

4.0 FAA FLIGHT REGULATIONS

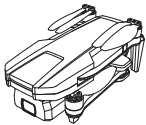
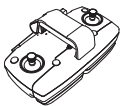
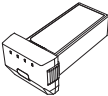
- Observe local FAA rules and regulations for flight.
- Do not fly in unpermitted locations.
- Go to www.faa.gov/uas to learn more about FAA drone regulations.
- This drone weighs over 250g and requires registration.

5.0 PACKAGE CONTENTS

		
Drone	Transmitter	Drone Battery
		
Propeller	USB Charging Cable	Screwdriver
		
Instructions For Use		

6.0 DRONE DETAILS

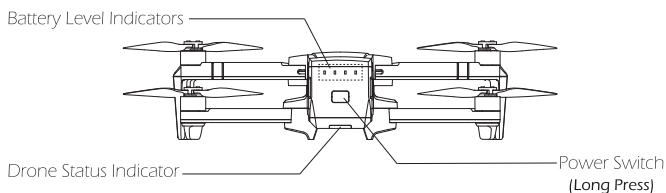
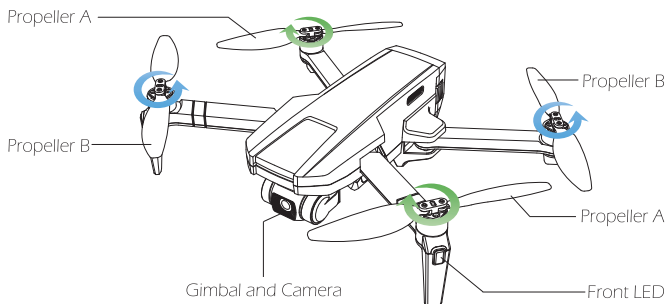



- The front LEDs glow solid white to display the orientation of the drone.
- The drone status indicator displays the status of the flight control system.
- The battery level indicators display the battery level when the drone is powered on.

7.0 TRANSMITTER DETAILS

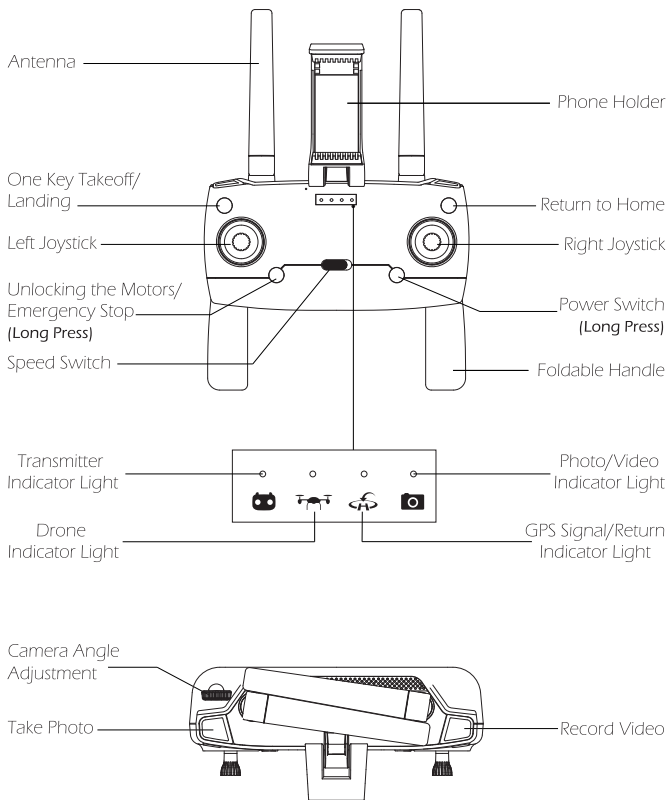
7.1 Transmitter Functions





- You can check the current battery status of the transmitter by short pressing the power switch button () once. Please fully charge the battery of the transmitter before use. When fully charged, the transmitter can work for 2.5 hours.
- Long press the () button to switch the GPS Mode on or off. If the GPS Mode is off, the max flight altitude of the drone is 394 ft.

• Photo/Video

Short press the photo button () and the Photo/Video Indicator Light flashes twice on the transmitter, the camera takes one photo.

Short press the video button () and the Photo/Video Indicator Light flashes slowly on the transmitter, the camera will start recording a video.

Short press the button again will stop video recording.

• Camera Angle Adjustment

The 3-axis gimbal provides a steady platform for the attached camera, allowing you to capture clear, stable images and videos. The camera has a 70° tilt range. You can scroll the wheel () on the transmitter to tilt the camera up/down.

• Speed Switch

This drone comes with 3 speed modes (Low/Medium/High). Toggle the speed switch () to select the speed mode.

L: The transmitter beeps once, indicating Low Speed.

M: The transmitter beeps twice, indicating Medium Speed.

H: The transmitter beeps three times, indicating High Speed.

• Return to Home (RTH)

Short press the RTH button () to start the RTH, the transmitter makes a beep sound and the drone will fly back to the recorded Home Point.

Short press the RTH button () again to exit the RTH procedure and regain control of the drone.

• Emergency Stop

Press and hold the () button for 3 seconds, the motors will stop immediately. To avoid irreparable damage to the drone, this function can only be triggered when the flight height is lower than 16 ft and the flight distance is within 49 ft.

 The Emergency Stop function should only be used during emergency to avoid any damage or injury. Be aware that you risk breakage of the drone if it falls a large distance or hits anything at a high rate of speed.

7.2 Joystick Mode

Left Joystick



Right Joystick

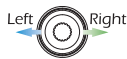

8.0 CHARGING

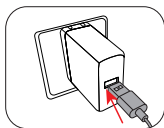

USB Adapter
(5V/2A)
(Not included)

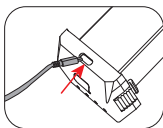

Charging time: about
5 hours

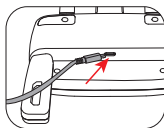
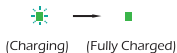

Charging time: about
1.5 hours

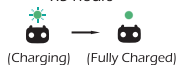

Connect the USB charging cable to a USB Adapter(5V/2A), and then connect with the charging port of the drone or transmitter.



- Before charging, please read the instructions in the “Use of Battery” section of the “Safety Guidelines” carefully!
- DO NOT charge the drone battery immediately after a flight as the temperature of the battery may be too high. Please wait until it cools down to room temperature before charging again.

9.0 PREPARATION BEFORE FLIGHT

9.1 Download APP



iOS



Android APP on Google Play

Scan the QR code, corresponding to either App Store™ or Google Play™ Store and download the **Ophelia FLY** app for free.

Required Operating Systems: iOS 9.0 or later/Android 5.0 or later.

9.2 Arms



All arms of the drone are folded before the drone is packaged at the factory. First, unfold the front arms, then unfold the rear arms.

9.3 Gimbal Cover

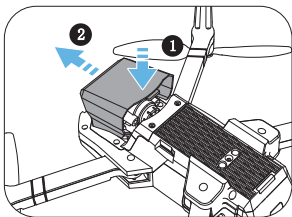

As shown above, turn the drone over, press down on the edge of the gimbal cover to unlock the buckle, then push it out and take it away.



- Please remove the gimbal cover gently before powering on the drone.
- Please put the gimbal cover back on when the drone is not in use.

9.4 TF Card

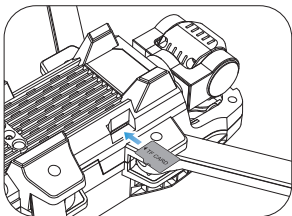

To store your photos and videos, insert the TF card (**not included**) into the slot as shown above before turning on the drone. The drone supports TF card up to 128 GB.

9.5 Drone Battery

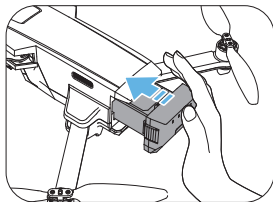

Installation: Push the battery into the battery compartment at the rear of the drone. Make sure that you hear a click sound, which indicates that the battery is firmly installed.



- Before installing the battery, please remove the insulation gasket from the battery.
- The battery should be installed firmly. Otherwise, the flight safety of your drone may be affected. The drone may crash due to a power-cut during the flight.

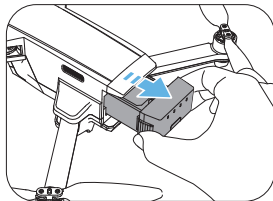

Removal: As shown above, press the battery lock on both sides of the battery, and pull it out to remove the battery.

9.6 Propellers

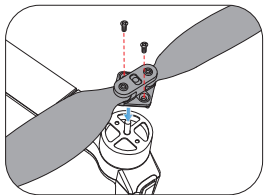
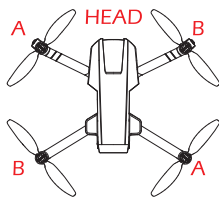

Installation: The drone will not fly unless the correct propeller is installed on the correct motor shaft. See the illustration above. An “A” or “B” is printed on the back of each propeller. Lock the propeller to the motor shafts with screws. Please rotate each screw clockwise.

 The propeller is installed before the drone is packaged at the factory.

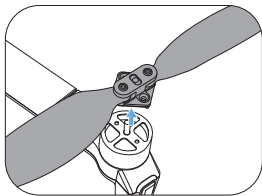
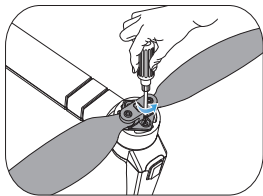

Removal: For propeller removal, use a screwdriver (provided) to rotate counter-clockwise and remove the propellers. Be sure to hold the motor while detaching the propeller.

9.7 Antenna

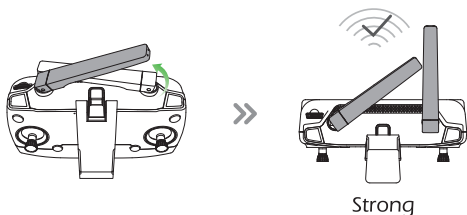

Expand the two antennas on the transmitter before starting the flight. To get the best signal, position the antennas like a triangle, as depicted above on the right.

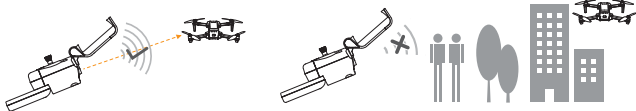

The signal between the drone and the transmitter is most reliable when the transmitter is positioned toward the drone, as depicted above on the left.



If the transmission signal is weak during flight, adjust the orientation of the transmitter to ensure that the drone is within optimal transmission range.

9.8 Foldable Handle

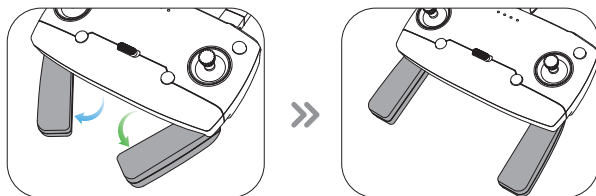

As shown above, expand the foldable handle on the transmitter separately.

9.9 Phone Holder

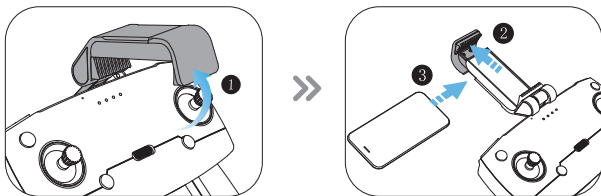

Expand the phone holder and place your mobile phone in it. Adjust the clamp to secure your mobile phone.

10.0 FLIGHT

All of the operations shown in this manual are demonstrated using **MODE 2**.

• Pre-Flight Checklist

1. Make sure the transmitter, the mobile phone and the drone battery are fully charged.
2. Make sure the drone battery and the propellers are mounted securely.
3. Make sure the drone arms are unfolded.
4. Make sure that there is nothing obstructing the motors.
5. Make sure that the camera lens and vision positioning lens are clean.

10.1 Pairing

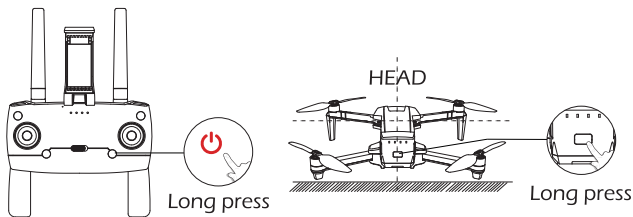

- ① Long press the power switch () on the transmitter. The transmitter indicator light starts flashing.
- ② Turn on the drone, and place it on a level surface with its head forward. The drone status indicator starts flashing.
- ③ It takes about 25 seconds for the transmitter to connect to the drone. The transmitter sends out a long beep when the pairing is done.

 When changing another battery, you don't need to turn off the transmitter and exit the APP, the drone and the transmitter can be connected automatically.

10.2 Initialization Detection

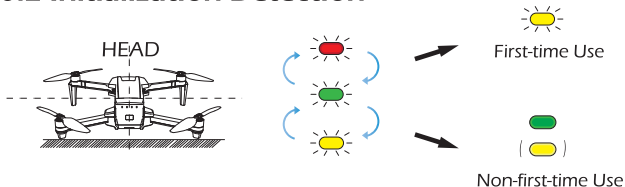

Place the drone on the level surface and it will enter the initialization detection. The drone status indicator will alternate between red, green and yellow. There are two possible scenarios:

- **First-time Use:** The drone status indicator will flash yellow.
- **Non-first-time Use:** The drone status indicator changes to green (yellow).

10.3 Connect to Wi-Fi



Connect your phone to the Wi-Fi network created by the transmitter. You can check the drone's status on the **Ophelia FLY** app.

- ① Make sure to turn off Bluetooth, Mobile Data, and VPN. Enter your phone's Wi-Fi settings and click Wi-Fi to search for the Wi-Fi of the transmitter. (Make sure the pairing has finished before going to the Wi-Fi settings on your phone)
- ② Select the Wi-Fi network: **HolyStoneGIM-*******.
- ③ Wait for a couple of seconds for your phone to connect to the transmitter's Wi-Fi.
- ④ Enter the **Ophelia FLY** application.

> The connection between your phone and the drone is established automatically.

 The Wi-Fi network created by the transmitter cannot access the internet, your phone may inform you, like saying the connection isn't secure, or there is no internet connection, etc. Please ignore these messages. Or, in the case of getting prompts, choose the option that allows you to stay with the current Wi-Fi.

10.4 Calibrating the Compass

 The drone will perform a mandatory compass calibration before the initial flight. So you can skip step 1 if this is the first time you fly your drone.

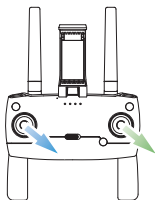

Step 1: As shown in the figure above, push both of the joysticks down to the bottom right corner at the same time to enter the compass calibration. The drone status indicator will flash yellow slowly, which indicates that the calibration has started.

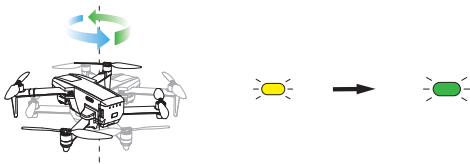

Step 2: Hold the drone horizontally and rotate it three times. When completed the drone status indicator will flash green slowly.

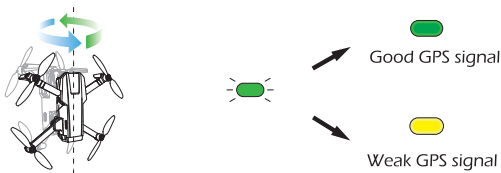

Step 3: Hold the drone vertically and rotate it three times. When completed, the drone status indicator will turn solid green if the GPS signal is strong, otherwise it will turn solid yellow, which means that the GPS signal is weak.



- To ensure a stable flight, we recommend that pilots perform a compass calibration before each flight.
- DO NOT calibrate the compass in locations where magnetic interference may occur, such as close to magnetite deposits or large metallic structures such as parking structures, steel reinforced basements, bridges, cars, or scaffolding.
- DO NOT carry objects (such as mobile phones) that contain ferromagnetic materials near the drone during calibration.

10.5 Unlocking the Motors

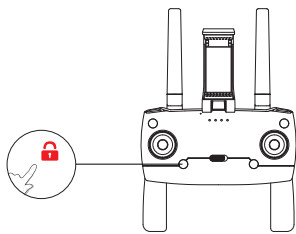

Short press the () button. The motors rotate, and the drone is unlocked.

10.6 One Key Takeoff/Landing

Please unlock the motors before takeoff.

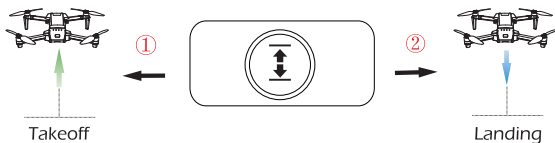

① Short press the () button, the drone will automatically take off and hover at 3 ft.

② When the drone is flying, short press the () button, the drone will automatically land on the ground.

- 💡 · Before you are familiar with all the functions of the drone, please fly it outdoors in an open space.
- When the GPS Mode is on, the maximum flight altitude of the drone is 49 ft if the GPS signal is weak or unavailable.

11.0 RETURN TO HOME(RTH)

- The Return to Home function brings the drone back to the recorded Home Point.
- The default Home Point is the first location where the drone receives a strong GPS signal (the GPS Signal Indicator on the transmitter turns solid green at this point).

11.1 Smart RTH

If the GPS signal is available (The GPS Signal Indicator is solid green) and the Home point is recorded previously. Press the () button on the transmitter, then the drone will fly back to the Home Point automatically.

Exit the RTH mode by pressing the () button again.

11.2 Failsafe RTH

If the GPS signal is available (The GPS Signal Indicator is solid green) and the Home Point is recorded previously. Failsafe RTH will be triggered when the transmitter signal is lost for more than 6 seconds. The drone will fly back to the Home Point automatically. If the transmitter's signal is recovered and you want to exit the Failsafe RTH, you can press the () button again.

 The default RTH altitude for the above two Return Home modes is 49ft. You can also preset the RTH altitude in the App. There are 2 possible scenarios:

- a. When the drone's current altitude is higher than or equal to the preset RTH altitude, the drone will maintain its current altitude, fly back above the Home Point, then descend to the ground.
- b. When the drone's current altitude is lower than the preset RTH altitude, the drone will first ascend to the preset RTH altitude, fly back above the Home Point, then descend to the ground.

11.3 The First Stage of Low Voltage RTH: The First Stage of Low Voltage RTH is automatically triggered when the battery level displays (🔋). At this time, the drone status indicator will start to flash red slowly, the transmitter will start to keep beeping, and the GPS Signal/Return Indicator Light will start to blink slowly. The drone will return to 98 ft above the Home Point. There are two ways to return:

a. When the flight altitude is higher than 98 ft, the drone will first fly back above the Home Point, then descend to 98 ft, and exit the first stage of Low Voltage RTH.

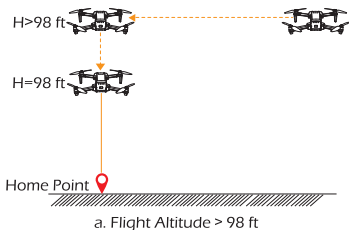

b. When the flight altitude is lower than 98 ft, the drone will first ascend to 98 ft, then fly back above the Home Point, and exit the first stage of Low Voltage RTH.

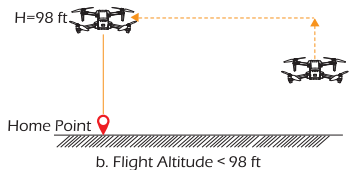

 If the drone is within the safe range (Flight Altitude ≤ 394 ft, Flight Distance ≤ 984 ft), it will not perform a Return to Home procedure. At this time, the pilot is free to operate the drone. (the horizontal distance between the Home Point and the drone)

11.4 The Second Stage of Low Voltage RTH: The Second Stage of Low Voltage RTH is automatically triggered when the battery level displays (🔋). At this time, the drone status indicator will start to flash red quickly, the transmitter will start to keep beeping, and the GPS Signal/Return Indicator Light will start to blink slowly. The drone will return automatically to the Home Point. There are three ways to return:

a. When the flight altitude is higher than or equal to 49 ft, the drone will keep its current altitude, return above the Home Point, then descend and land onto the ground.

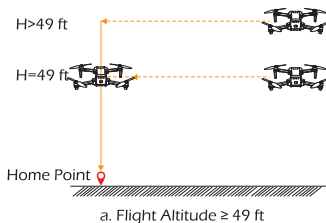

b. When the flight altitude is lower than 49 ft and the flight distance is greater than 49 ft, the drone will first ascend to 49 ft, fly back above the Home Point, then descend to the ground.

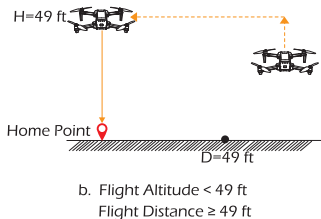

c. When the flight altitude is lower than 49 ft and the flight distance is smaller than 49 ft, the drone will descend directly to the ground.

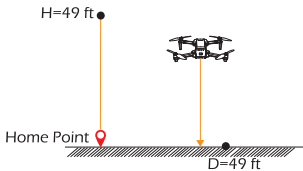

c. Flight Altitude < 49 ft
Flight Distance < 49 ft



































- During the RTH procedure, the drone can NOT avoid obstacles.
- When there is a pre-recorded Home Point, but the drone cannot receive any GPS signal, the RTH procedure cannot be completed. The drone will just maintain its current altitude and position.
- When there is no pre-recorded Home Point and the drone receives no GPS signal, the RTH procedure can not be activated.

12.0 APP OPERATION INSTRUCTION

12.1 Operation Interface



1		Homepage: Tap this icon to return to the main menu.
2		GPS Signal: Displays the current GPS signal strength.
3		Drone Battery Level: Real-time display of the current battery level of the drone.
4		Transmitter Battery Level: Real-time display of the current battery level of the transmitter.
5		Transmitter Signal Strength: Displays the current signal strength between the drone and the transmitter.
6		Wi-Fi Signal Strength: Displays the current signal strength between the transmitter and the mobile phone.
7		Hide: Tap to hide the icons on the interface.
		VR: Tap to split the screen. Then place the mobile phone into a VR headset (not included) to watch the live feed in 3D.
		180° Screen Rotation: The phone's screen will rotate 180°.

8		Flight Setting: Tap to enter the setting interface. Alter settings for flight height/distance, return altitude, etc.
9	 	Follow Me Mode: Tap the icon and the drone can automatically follow the pilots according to the GPS positioning of the phone.
		Point of Interest: The drone will fly around a point.
10		Return to Home: Tap to bring the drone back to the Home Point.
11		One Key Takeoff/Landing: Tap once, the drone will take off and hover at 3 ft. Tap again, the drone will slowly land on the ground.
12		Album: Tap to view photos and videos taken by the drone's camera.
13		 Free Mode: Tap to shoot time-lapse video in the Free Mode.
		 Dronie Mode: Tap to shoot time-lapse video in the Dronie Mode.
		 Straight Mode: Tap to shoot time-lapse video in the Straight Mode.
		 Circle Mode: Tap to shoot time-lapse video in the Circle Mode.
14		Photo/Video: Tap to switch between photo taking and video recording.
15		Take Photo: Tap to take a photo.
		Record Video: Tap to record videos. Tap once to start recording, tap again to stop recording.
16		Camera Settings: Tap to enter camera settings.
17		 Track: Draw a line on the screen to create a path, and the drone will fly along the path.
		 Point: Tap a few points on the screen. The drone will fly along the path created by connecting the points you tap in order.
18		Delete: Tap to delete the route.
19		Submit: Tap to submit the route.
20		Map: Tap to switch between Camera View and Map View.
21		Distance: Horizontal distance from the Home Point.
22		Height: Vertical distance from the Home Point.
23		Zoom Trigger: Scroll left and right to control the zoom in and zoom out.

12.2 Beginner Mode

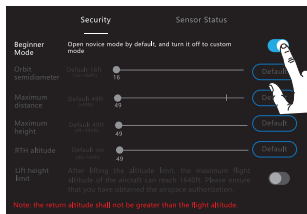

Flight Settings
On APP



The default GPS mode is the beginner mode. When in this mode:

1. The default Orbit semi-diameter is 16 ft.
2. Flight Distance is limited between 0~49 ft.
3. Flight Height is limited between 0~49 ft.
4. The default RTH Altitude is 49 ft.

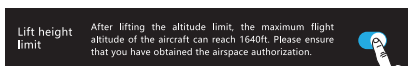
To modify the parameters in the app, please turn off the beginner mode.





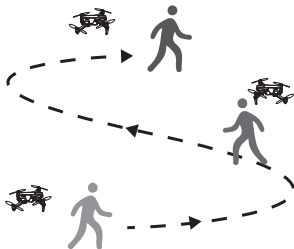

If you want to get a higher flying altitude, you can activate the Lift Height Limit function to boost the maximum flight altitude up to 1640 ft. Please ensure that you have obtained the airspace authorization.

12.3 Follow Me







When the Follow Me function is enabled, the drone will track your movement by following the GPS signal on your mobile phone.

1. Ensure the drone's flight range is within 16~98 ft.
2. Tap the () icon first, then select the () icon, and follow the prompt box to enter the Follow Me function — the drone will now follow the mobile phone's coordinates.
3. To exit Follow Me Mode, simply tap the () icon on the app interface again.

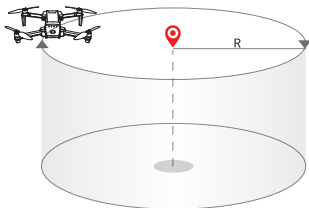



-  · The Follow Me function can only be used if the flight range is within 16~98 ft.
- Follow Me function may be difficult to activate if the mobile phone's GPS signal is too weak. This could be caused by signal interference from surrounding buildings, trees, mobile network congestion etc.
- Please use Follow Me function in an open area and be mindful of your surroundings. The drone is NOT equipped with obstacle avoidance.

12.4 Point of Interest



1. Tap the () icon first, then select the () icon, and follow the prompt box to enter the Point of Interest function.
2. The moment you enter this function, the drone will record its current flight position as the “point of Interest”. It will then continuously circle around that point clockwise. (The default radius is 16 ft).
3. To exit Point of Interest mode, simply tap the () icon on the app interface again.

12.5 Take Photo/Record Video





1. Tap the () icon to switch between photo and video recording modes.
2. Tap the () icon to take a photo.
3. Tap the () icon to start recording a video. Tap again to stop recording.
4. To view the photos and videos, tap the () icon to enter the album.
5. Without the TF card installed, the photos and videos will be saved in app albums.
6. After installing the TF card, the photos and videos will be saved in both the app albums and the TF card.
7. If you want to view the photos and videos stored in the TF card from the app, please make sure that the phone is connected to the Wi-Fi of the transmitter.

12.6 Time-lapse

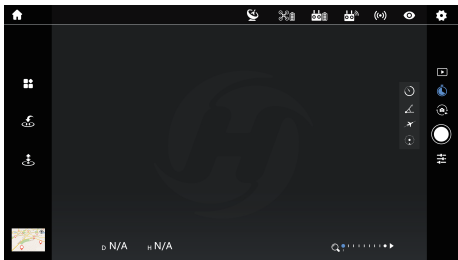
* Please be sure to insert a TF card before using time-lapse function.

The drone can shoot time-lapse videos in four modes: Free, Dronie, Straight, and Circle.



-  **Free Mode:** By setting the playback speed, the drone will take a number of photos to generate a time-lapse video. You are free to operate the drone while it's shooting the time-lapse video.
-  **Dronie Mode:** Choose angle, set video duration, video playback speed and flight speed. The drone will fly backward and ascend, while taking a time-lapse video.
-  **Straight Mode:** Choose flying direction, set video duration, video playback speed and flight speed. The drone will fly towards that direction, while taking a time-lapse video.
-  **Circle Mode:** Set circle direction, radius, flying time and video playback speed. The drone will fly in circle, while taking a time-lapse video.



Follow the steps below to generate time-lapse videos:

1. Entering: Tap the () icon on the app interface to enter the time-lapse function.

2. Mode Selection: You can choose one of the following four modes: Free, Dronie, Straight, and Circle .

3. Parameter Setting: Set the time-lapse parameters after you select the desired mode.

4. Starting: Swipe to confirm.

 If you want to cancel the selection of the current mode, click the () to exit the time-lapse function.



5. Exiting: The shooting will end automatically when the estimated flight time is over. You can also end the shooting by tapping the () button. The drone will hover in place.



EXCEPTION: When in Free mode, you can only exit the time-lapse function by tapping the () button

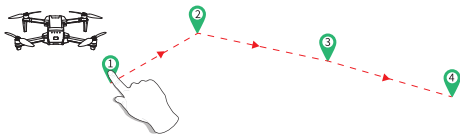

12.7 TapFly

* Please download the map before using the TapFly.



1. Tap on the map () first, then tap the () icon. Follow the prompt box to enter the TapFly function.

MODE 1: Tap the () icon on the app interface. Draw a line on the screen to create a flight path, tap () icon to submit the path. The drone will then fly along this path.

MODE 2: Tap the () icon on the app interface, then tap a few points on the screen. Tap the () icon to submit the path. The drone will then fly along the path created by connecting the points you tap in order.

2. Exit the TapFly function by tapping the () icon again.

3. If the flight path submission fails, you can submit it again, or exit the function.

 · DO NOT fly the drone towards people, animals, or small/thin objects (e.g. tree branches and power lines) or transparent objects (e.g. glass or water).

 · To download the map:

① Disconnect your mobile phone from the transmitter's Wi-Fi network.

② Connect your mobile phone to the internet and enter the map to get the current location information, the map will load automatically.

③ Reconnect your mobile phone to the transmitter Wi-Fi network and come back to this function.

· We strongly recommend you to enlarge the map when using TapFly.

· There may be some deviation between the expected and actual flight paths.

13.0 STABILIZATION FUNCTION

13.1 Altitude-Hold Function

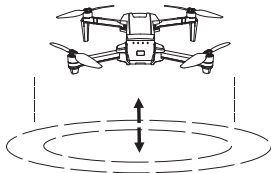

The drone is designed with an altitude-hold function to maintain its altitude after releasing the left joystick. (The left joystick will automatically spring back to the middle)

13.2 Optical Flow Positioning

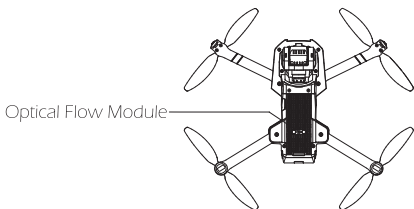

The Optical Flow Positioning System consists of a camera module, which acquires the position information of the drone through visual images to ensure precise positioning of the drone.

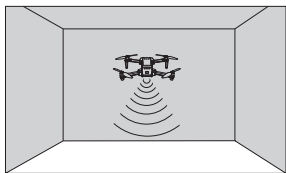

The Optical Flow Positioning System is typically used in an indoor environment when the GPS signal is weak or unavailable. It works best when the drone altitude is less than 10 ft.









· The precision of the Optical Flow Positioning System is easily affected by the light intensity and features of the surface textures. Once the image sensor is not available, your drone will switch to the altitude-hold function automatically. Please be cautious to operate the drone in the following situation:

1. Fly fast at an altitude below 2 ft.
 2. Fly over monochrome surfaces (e.g. pure black, pure red and pure green).
 3. Fly over highly light reflective surfaces.
 4. Fly over water or transparent surfaces.
 5. Fly over moving surfaces or objects.
 6. Fly in an area where the lighting changes dramatically and frequently.
 7. Fly over extremely dark (<10 lux) or bright (> 10,000 lux) surfaces.
 8. Fly over surfaces without clear patterns or textures.
 9. Fly over surfaces with highly repeating textures (small grid brick in the same color).
- Flying speed should be controlled not to be too fast. When the drone is 3 ft from the ground, the flying speed should not be over 16 ft/s. When the drone is 7 ft from the ground, the flying speed should not be over 33 ft/s.





- Keep sensors clean at all times.
- The Optical Flow Positioning is only effective when the drone is within the altitude range of 10 ft.
- Make sure that the light is bright enough and the surface is with clear textures so that the Optical Flow Positioning can acquire the movement information through recognizing the ground textures.
- The Optical Flow Positioning may not function properly when the drone is flying over water, low light ground and surfaces without clear patterns or textures.

14.0 STATUS INDICATOR STATES

• Drone Status Indicator States

	Indicator Status	Meanings
	Flash quickly	Drone is disconnected to the transmitter
	Flash alternating	Initialization detection
	Solid	No GPS Signal or weak GPS Signal
	Solid	Good GPS Signal
	Flash slowly	Entering the First Low Voltage RTH
	Flash quickly	Entering the Second Low Voltage RTH

• Transmitter Status Indicator States

	Indicator Status	Meanings
 <p>Transmitter Indicator Light</p>	Solid	Transmitter is paired with drone or transmitter battery is fully charged
	Flash slowly	Transmitter battery level is low or transmitter battery is charging
	Flash quickly	Transmitter is pairing with drone
 <p>Drone Indicator Light</p>	Solid	Drone is connected with transmitter
	Off	Drone is disconnected with transmitter
	Flash quickly	The battery level of drone is low
 <p>GPS Signal/Return Indicator Light</p>	Solid	GPS Signal is strong
	Off	GPS Signal is weak or GPS Mode is off
	Flash slowly	Drone is returning to Home Point
 <p>Photo/Video Indicator Light</p>	Flash twice	Take photo
	Flash slowly	Record video

15.0 SPECIFICATIONS

DRONE

Model: HS720R

Weight: 389g/13.72oz

Max Flight Time: 26 minutes (per battery)

Operating Temperature Range: 14° to 104°F

Size: 168*99*71mm(Folded)

305*238*71mm(Unfolded)

DRONE BATTERY

Capacity: 2950mAh

Voltage: 7.7V

Battery Type: Lithium-ion Polymer Battery

Energy: 22.715Wh

Charging Temperature Range: 41° to 104°F

Charging Time: about 5 hours

TRANSMITTER

Operating Frequency: 2452-2474MHz

Charging Time: about 1.5 hours

Usage Time: about 2.5 hours

Max Flight Distance: 9842 ft (outdoor and unobstructed)

Battery Type: 3.7V 2000mAh Lithium-ion Polymer Battery

Operating Temperature Range: 14° to 104°F

GIMBAL

Stabilization: 3-axis (tilt, roll, pan)

Mechanical Range: Tilt about $\pm 30^\circ$

Roll about $\pm 30^\circ$

Pan about $\pm 30^\circ$

Controllable Range: Adjusted angle of camera (up and down):
about -70° to 0°

CAMERA

Operating Frequency: 5500-5700MHz

Max Photo Resolution: 3840×2160P

Max Video Resolution: 3840×2160P@30fps

Lens Angle: FOV 140°

Max Transmission Distance: 9842ft(outdoor and unobstructed)

Photo Formats: JPEG

Video Formats: AVI/MP4

Supported TF Cards: Supports a TF Card (Class10 above) with
capacity of up to 128 GB (Not included)

File Systems: FAT32

USB CHARGING CABLE

Input: 5V/2A

Rated Power: ≤ 10 W

16.0 CONTACT US

Please do not hesitate to contact us if you need further support.

 4:00 PM ~ 7:00 AM (PST)

 usa@holystone.com (America)
ca@holystone.com (Canada)
eu@holystone.com (Europe)

 +1(855) 888-6699



For online support, please scan
this code with Live Chat

17.0 GENERAL INFORMATION

FCC Notice:

This device complies with part 15 of the FCC Rules. Operation is subject to the following two conditions:

- (1) This device may not cause harmful interference, and
- (2) This device must accept any interference received, including interference that may cause undesired operation.

The Supplier's Declaration of Conformity is available at the following address:

https://www.holystone.com/Download/US/HS720R_FCC_sDoC.pdf

NOTE: This equipment has been tested and found to comply with the limits for a Class B digital device, pursuant to part 15 of the FCC Rules. These limits are designed to provide reasonable protection against harmful interference in a residential installation. This equipment generates, uses and can radiate radio frequency energy and, if not installed and used in accordance with the instructions, may cause harmful interference to radio communications. However, there is no guarantee that interference will not occur in a particular installation. If this equipment does cause harmful interference to radio or television reception, which can be determined by turning the equipment off and on, the user is encouraged to try to correct the interference by one or more of the following measures:

- Reorient or relocate the receiving antenna.
- Increase the separation between the equipment and receiver.
- Connect the equipment into an outlet on a circuit different from that to which the receiver is connected.
- Consult the dealer or an experienced radio/TV technician for help.

WARNING: Changes or modifications not expressly approved by the party responsible for compliance could void the user's authority to operate the equipment.

RF Exposure

The equipment complies with FCC radiation exposure limits set forth for an uncontrolled environment. This device should be installed and operated with minimum distance 20cm between the radiator & your body. This part belongs to the drone.

RF warning for Portable device: The device has been evaluated to meet general RF exposure requirement. The device can be used in portable exposure condition without restriction. This part belongs to the transmitter.

IC Notice:

This device is restricted to indoor use when operating in the 5150 to 5250 MHz frequency range.

This device complies with Industry Canada license-exempt RSS standard(s). Operation is subject to the following two conditions:

- (1) this device may not cause interference, and
- (2) this device must accept any interference, including interference that may cause undesired operation of the device.

CAN ICES-003 (B)

Avis d'Industrie Canada

Le présent appareil est conforme aux CNR d'Industrie Canada applicables aux appareils radio exempts de licence. L'exploitation est autorisée aux deux conditions suivantes :

- (1) l'appareil ne doit pas produire de brouillage, et

(2) L'utilisateur de l'appareil doit accepter tout brouillage radioélectrique subi, même si le brouillage est susceptible d'en compromettre le fonctionnement.

CAN NMB-003 (B)

RF Exposure

Radiation Exposure Statement:

The device is compliance with RF exposure guidelines, users can obtain Canadian information on RF exposure and compliance. The minimum distance from body to use the device is 20cm.

Le présent appareil est conforme

Après examen de ce matériel aux conformité ou aux limites d'intensité de champ RF, les utilisateurs peuvent sur l'exposition aux radiofréquences et compliance d'acquérir les informations correspondantes. La distance minimale du corps à utiliser le dispositif est de 20cm.

HOW TO RECYCLE THIS PRODUCT

This symbol on the product or its documentation indicates that it must not be disposed of with household waste.

Uncontrolled waste disposal may harm the environment or human health. Please separate your device from other types of waste to recycle it responsibly.

This will help to foster the sustainable re-use of material resources.

We invite you to contact your retailer or inquire at your local town hall to find out where and how the drone can be recycled.

BATTERY WARNING:

1. Failure to follow all the instructions may result in serious injury, irreparable damage to the battery and may cause a fire, smoke or explosion.

2. Always check the battery's condition before charging or using it.

3. Replace the battery if it has been dropped, or in case of odor, overheating, discoloration, deformation or leakage.

4. Never use anything other than the approval Li-Po charger to the battery. Always use a balancing charger for Li-Po cells or a Li-Po cell balancer. It is recommended that you do not to use any other charger than the one provided with the product.

5. The battery temperature must never exceed 60°C (140°F) otherwise the battery could be damaged or ignite.

6. Never charge battery on a flammable surface, near flammable products or inside a vehicle (preferably place the battery in a non-flammable and nonconductive container).

7. Never leave the battery unattended during the charging process. Never disassemble or modify the housing's wiring, or puncture the cells. Always ensure that the charger output voltage corresponds to the voltage of the battery. Do not short circuit the batteries.

8. Never expose the LiPo battery to moisture or direct sunlight, or store it in a place where temperatures could exceed 60°C(car in the sun, for example).

9. Always keep it out of reach of children.

10. Improper battery use may result in a fire, explosion or other hazard.



11. Non-rechargeable batteries are not to be recharged. Rechargeable batteries are only to be charged under adult supervision.
12. Different types of batteries or new and used batteries are not to be mixed.
13. Batteries are to be inserted with the correct polarity.
14. The supply terminals are not to be short-circuited. Regular examination of transformer or battery charger for any damage to their cord, plug, enclosure and other parts and they must not be used until the damage has been repaired.
15. The packaging has to be kept since it contains important information.
16. This toy should only be connected to the equipment with symbol Class II. 

EU RF Power (EIRP): <16 dBm (2452MHz ~ 2474MHz)

Caution

1. The max operating of the EUT is 45°C. and shouldn't be lower than -10°C.
2. The device complies with RF specifications when the device used at 0mm from your body.
3. Declaration of Conformity.

We, Xiamen Huoshiquan Import & Export CO., LTD hereby, declare that the essential requirements compliance with the Directive 2014/53/EU, the RoHS Directive 2011/65/EU and Safety Directive 2009/48/EC have been fully fulfilled on our product with indication below:

Product Name: REMOTE CONTROL MODEL/RADIO CONTROLLED

Model/Mark: HS720R/HOLYSTONE

The Statement of compliance is available at the following address:
http://www.holystone.com/Download/CE/HS720R_EU_DOC.pdf
This product can be used across EU member states.

MANUFACTURER INFORMATION

Manufactured by

Xiamen Huoshiquan Import & Export CO.,LTD

Address: Unit 1, Room 501, Hongxiang Building, No.258 Hubin Nan Road,
Siming District, Xiamen, China

+1(855) 888-6699



MADE IN CHINA(CN)