



16+
age

Instructions For Use

Gebrauchsanweisung

V2.0

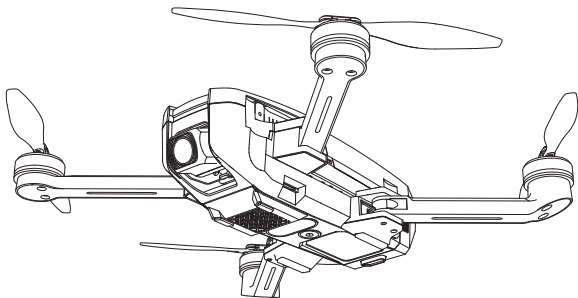

HS720E

 +1(855) 888-6699

 www.holystone.com

 usa@holystone.com (USA)
ca@holystone.com (CA)

eu@holystone.com (EU)

English

01-44

Deutsch

45-85

Contents

1.0 Disclaimer&Warning	01
2.0 Safety Guidelines	01
3.0 Maintenance	05
4.0 Package Contents	06
5.0 Drone Details	07
6.0 Transmitter Details	
6.1 Transmitter Functions	08
6.2 LCD Screen Functions	10
6.3 Low Battery Warning	10
6.4 Mode Switch	11
7.0 Installation	
7.1 Drone Battery	12
7.2 Propellers	13
7.3 TF Card	14
7.4 Preparing the Drone	14
7.5 Phone Holder	15
7.6 Transmitter Battery.....	16
7.7 Antenna	16
8.0 Charging	17
9.0 Operation Guide	
9.1 Download APP	18
9.2 Connect to Wi-Fi	18
9.3 Paring	19
9.4 Initialization Detection	20
9.5 Calibrating the Compass	20
9.6 Unlocking	22
9.7 One Key Takeoff / Landing	23

10.0 Functions Details	
10.1 Camera Angle Adjustment	23
10.2 Return to Home	24
10.3 Optical Flow Positioning	27
11.0 APP Operation Instruction	
11.1 Operation Interface	29
11.2 Follow Me	30
11.3 Point of Interest	31
11.4 Headless Mode	32
11.5 TapFly	33
11.6 Take Photo/ Video	34
12.0 Drone Status Indicator	35
13.0 Specifications	36
14.0 Trouble Shooting	38
15.0 Contact Us	38
16.0 General Information	39

1.0 DISCLAIMER & WARNING

1. Please read this Disclaimer & Warning and Safety Guidelines carefully before using our product. This product is not recommended for people under the age of 16. By using this product, you hereby agree to this disclaimer and signify that you have read it fully. You agree that you are responsible for your own conduct and any damaged caused while using this product, and its consequences . You agree to use this product only for purposes that are proper and in accordance with local regulations, terms and all applicable polices and guidelines Holy Stone may make available.

2. When using this product, please be sure to strictly abide by the specification requirements and safety guidelines stated in this document. Any personal injury, property damage, legal disputes and all other adverse events caused by the violation of the safety instructions or due to any other factor, WILL NOT be Holy Stone's responsibility.

3. Please respect people's right to privacy while using your drone.

2.0 SAFETY GUIDELINES

2.1 Check Before Use:

① This product is a high precision drone that integrates various electronic stability and control mechanisms. Please be sure to setup this drone carefully and correctly to ensure safe, accident-free operation.

② Please be sure that the batteries of the drone and transmitter are clean, undamaged and, fully charged.

③ Please be sure that all the propellers are undamaged and are installed in the correct orientation.

④ Please do a thorough check of the product before each use. Inspect the integrity of the parts, any signs of cracks and wear of the propeller, battery power and effectiveness of the indicator, etc. If after doing a complete check any problems are found, please refrain from using the product until the problem has been resolved.

2.2 Flight Environment:



+



+



Fly in Open Areas

**Maintain Line
of Sight**

**Fly Below
390 feet (120 m)**



Avoid flying over or near obstacles, crowds, high voltage power lines, trees, airport or bodies of water.

DO NOT fly near strong electromagnetic sources such as power lines and base stations as it may affect the onboard compass.



Don't use this drone in adverse weather conditions such as rain, snow, fog, and wind.

2.3 Operation Requirements:

- ① Please don't use this product to follow any moving vehicles .
- ② During the flight, only turn the motor off the motor in case of an emergency.
- ③ As battery becomes low return the drone back to your starting point.
- ④ This product should not be used while consuming alcohol or drugs, if you are feeling fatigued, taking medicine, or feeling any physical discomfort.
- ⑤ Be aware of the volume of noise the drone produces. Keep your distance to avoid ear damage.



⑥ Stay away from the rotating propellers and motors.

⑦ Don't fly in any spaces where drones are prohibited.

2.4 Use of Battery:

- ① Please ensure batteries are fitted in the correct orientation as shown in the instruction manual.
- ② Avoid short circuits by fitting the batteries correctly, and do not crush or squeeze the batteries as this could cause the risk of a burn or explosion.
- ③ Do not mix new and old batteries as this can lead to a poor performance of the product.
- ④ Dispose used batteries carefully, do not litter. Please recycle if possible.
- ⑤ Please keep dead batteries away from heat and fire, as this could cause an explosion.
- ⑥ If the device is not going to be used for an extended period of time, remove batteries to prevent potential damage from battery leakage.

- ⑦ It is recommended to only use the USB charging cable that comes with the drone to charge the battery.
- ⑧ Do NOT connect the battery directly to wall outlets or car cigarette -lighter sockets, as this WILL damage your battery. The ONLY suitable source for charging are USB ports on a computer or a suitable USB charging block.
- ⑨ Do NOT attempt to disassemble or modify the battery in any way.
- ⑩ Do NOT use the battery if it gives off an odor, generates excess heat, becomes discolored or deformed, or appears abnormal in any way. If any of these situations occur while the battery is in use or being charged, remove it from the device or charger immediately and discontinue use. Dispose or recycle this battery as it may cause personal injury or damage to your drone.
- ⑪ Do NOT pierce the battery casing with a nail or any other sharp object, break it open with a hammer, or step on it!
- ⑫ Always charge the batteries on a fireproof surface and away from combustible materials. Do NOT charge on surfaces that can catch fire. This includes: wood, cloth, carpet, or inside the device.
- ⑬ Do NOT immerse the battery in water or allow it to get wet.
- ⑭ Do NOT solder the battery in any way.
- ⑮ Keep batteries and drone out of reach of children or pets.
- ⑯ Do NOT short-circuit the battery by connecting wires or other metal object to the positive(+) and negative(-) terminals.



Li-Po Battery Disposal & Recycling





Waste Lithium-polymer batteries must not be placed with household trash.
Please contact local environmental or waste agency or the waste agency
or the supplier of your model or your nearest Li-Po battery recycling center.

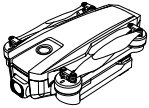
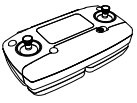
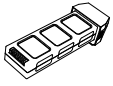

3.0 MAINTENANCE

- ① Clean the product after each use with a clean, soft cloth.
- ② Avoid prolonged exposure to direct sunlight and avoid buildup of heat on the drone or batteries.
- ③ This device is not waterproof and must not be submerged in water under any circumstance. Failure to keep the device completely dry will result in the failure and PERMANENT damage to of the unit. Be aware that although it might be dry where you are, droplets of rain or mist from a river or waterfall could be damaging your drone where it is flying.
- ④ Check the charging plug and other accessories for signs of damage frequently. If any part of the device or cables are damaged, avoid use or charging until the device can be serviced.

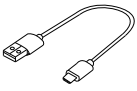
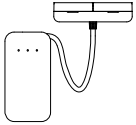
4.0 PACKAGE CONTENTS

		
Drone	Transmitter	Drone Battery
		
Propeller	USB Charging Cable	Charger Hub
		
Screwdriver	Instructions For Use	

5.0 DRONE DETAILS

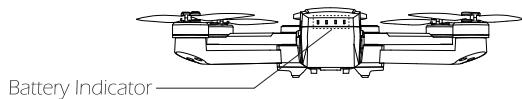
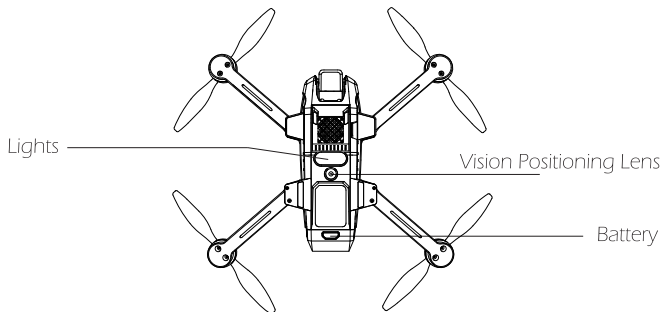
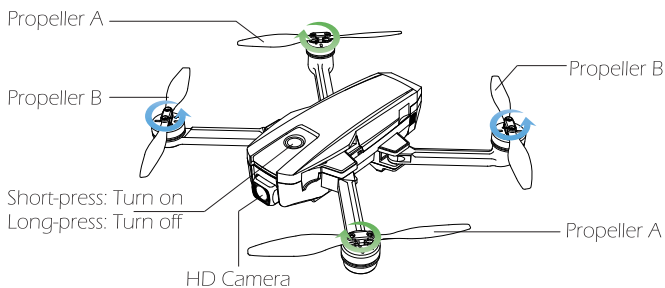

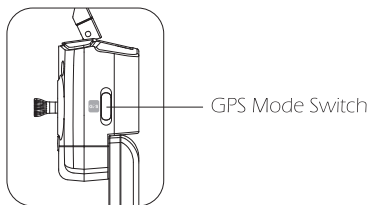
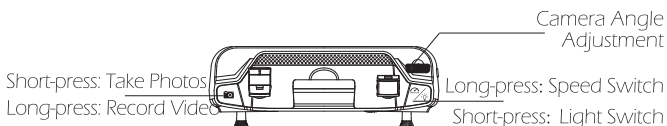
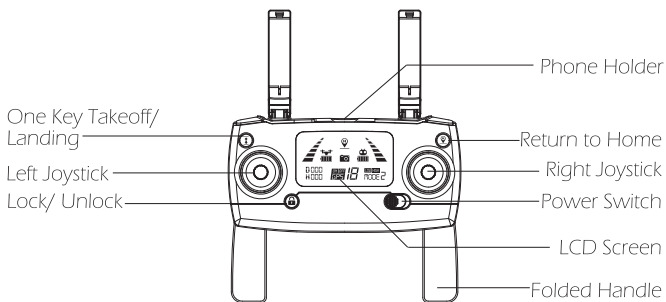

6.0 TRANSMITTER DETAILS

6.1 Transmitter Functions



• GPS Mode Switch

When turning on the transmitter, the default mode is the GPS Mode. Turn off GPS by sliding GPS switch. Check the icon “” or “” on the LCD screen to confirm GPS status.

• Return to Home (RTH)

Press the button to start the RTH, the transmitter makes a beep sound and the drone will fly back to the recorded Home Point.

Press the RTH button again to exit RTH procedure and regain control of the drone.

• Emergency Stop

Press and hold the button “” for 3 seconds, the motors will stop immediately. The range of the Emergency Stop is limited to a height of 16 feet and a distance of 49 feet.

Attention: The Emergency Stop function should only be used during emergency to avoid any damage or injury. Be aware that you risk breakage of the drone if it falls a large distance or hits anything at a high rate of speed.

• Photo/ Video

Short press the button and the camera icon “” on the LCD screen flashes once, the camera takes one photo.

Long press the same button, the video icon “” on the LCD screen flashes slowly the camera is taking video. Long press again will exit shooting.

• Speed Switch

Long press the button “” in the upper right corner, the LCD screen showing “**LOW**”, and you will hear a beep, which means the drone is at the low speed.

Long press the button “” again, the LCD screen showing “**HIGH**”, and you will hear two beeps, which means the drone is at the high speed.

6.2 LCD Screen Functions

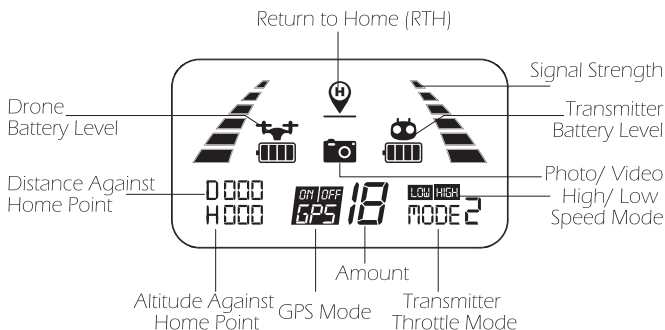

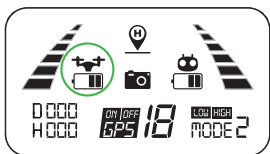

6.3 Low Battery Warning

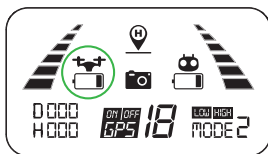

Pic. 1



Pic. 2



1. When the battery icon “” is shown on the LCD screen (Pic.1), and the drone front lights glow solid on and the rear lights keep flashing slowly, it means that the battery is nearly low voltage.
2. When the battery icon “” is shown on the LCD screen (Pic.2), and the drone front lights glow solid on and the rear lights keep flashing rapidly, it means that the battery is in low voltage.

6.4 Mode Switch

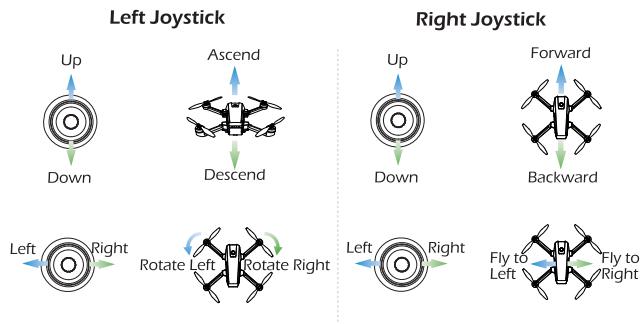
6.4.1 MODE 2 (Left hand throttle MODE 2 will be default setting.)



6.4.2 MODE 1

- ① Hold down the “” and then turn on the power switch.
- ② Press the “” button for 3 seconds to enter MODE 1.

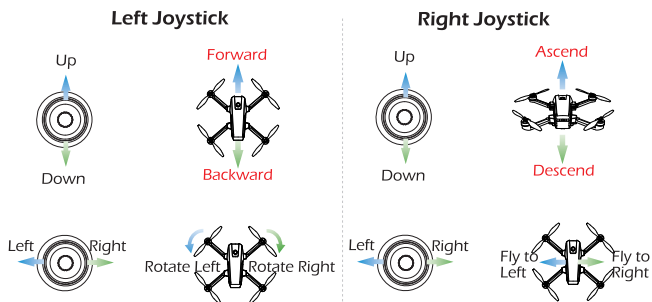

7.0 INSTALLATION

7.1 Drone Battery

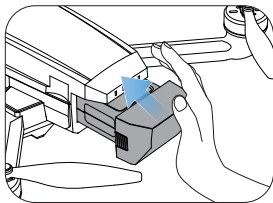

Push the battery into the battery compartment at the rear of the drone. Make sure that you hear a click sound indicating the battery is firmly installed.

Attention:

- Before installing the battery, please remove the insulation gasket from the battery.
- The battery should be installed firmly, failure to do so may affect the flight safety of your drone. The drone may crash due to power-cut during the flight.

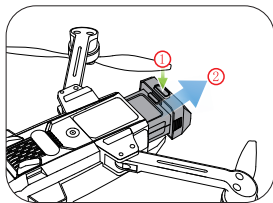

Removal: As shown above, press and hold the lock on the back of the battery at the same time while pulling backwards to remove the battery.

7.2 Propellers

Installation

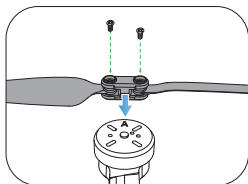
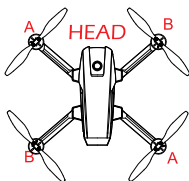

The drone will not fly unless the correct propeller is installed on the correct motor shaft. See illustration above. An “A” or “B” is printed on the back of each propeller. Lock the propeller to the motor shafts with screws rotating each screw clockwise.

Removal

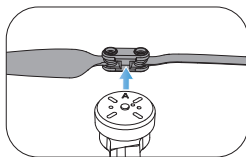
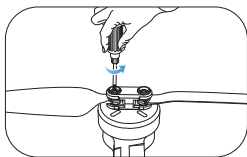

For propeller removal use screwdriver (provided) to rotate counter-clockwise and remove propellers.

7.3 TF Card

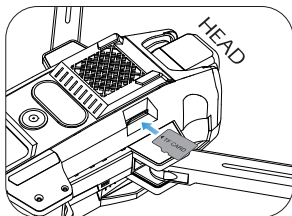

To store your photos and videos, insert the TF card (not included) into the slot as shown above before turning on the drone. The drone supports TF card up to 128 GB.

7.4 Preparing the Drone

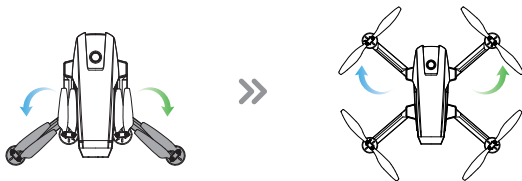

All arms of the drone are folded before the drone is packaged at the factory. First, unfold the rear arms, then unfold the front arms.

7.5 Phone Holder

1. Pull out the mobile phone holder upwards completely (Pic. 3).

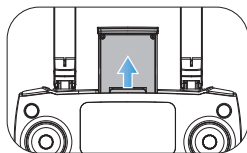

Pic. 3

2. Tilt the holder 30 degrees towards you and then you will hear a click sound (Pic. 4).

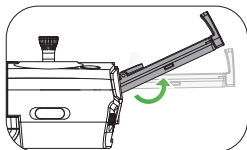

Pic. 4

3. Rotate and fix the support board in place (Pic. 5).

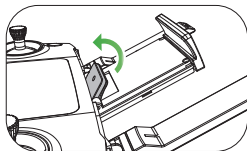

Pic. 5

4. Adjust the mobile phone holder upward or downward according to the size of your mobile phone (Pic. 6).

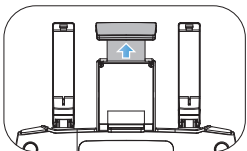

Pic. 6

7.6 Transmitter Battery

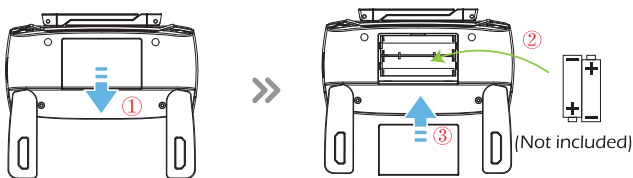

Step 1: Unfold the hand sticks and open the battery cover.

Step 2: Install 2*AA batteries into the battery compartment according to the given polarity.

Step 3: Close the battery compartment.



- Insert batteries with correct polarity.
- Do not mix old and new batteries.
- Exhausted batteries are to be removed from the transmitter.

7.7 Antenna

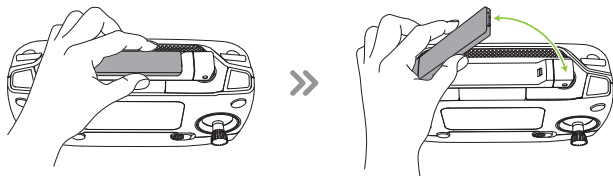

There is a buckle on the antenna, please follow the steps shown above to open the antenna.

8.0 CHARGING

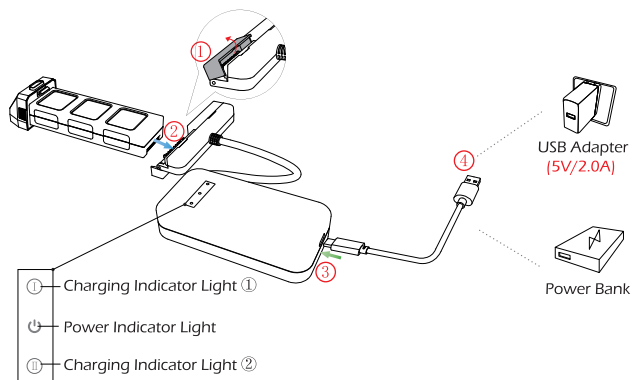

- ① Connect the Battery, Charger Hub and USB Charging Cable.
- ② Connect the USB Charging Cable with Power Bank or a USB Adapter (5V/2.0A) for charging.
- ③ When the battery is charging, the corresponding charging indicator of the battery is flashing green quickly, and the power indicator light is red.
- ④ When the battery is full charged, both the green and red lights will turn solid.
- ⑤ The charging time of a single battery is about 5 hours.



- Before charging, please check the contents of the “ **Use of Battery**” section of the “ **Safety Guidelines**” carefully!
- This product is only equipped with a single battery, you can choose to buy another battery to experience a longer flight.
- When the two batteries are being charged, the indicator light of the battery being charged flashes green quickly, while the indicator light of the battery waiting for charging flashes green slowly.

9.0 OPERATION GUIDE

9.1 Download APP



iOS



Android APP on Google play

Scan the QR code, corresponding to either App Store™ or Google Play™ Store and download the **Ophelia GO** app for free.

Required Operating Systems: iOS 9.0 or later/Android 5.0 or later

9.2 Connect to Wi-Fi

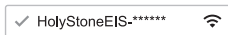

Connect your phone to the Wi-Fi network created by the drone. You can check the drone's status on the **Ophelia GO** App.

- ① Make sure to turn off Bluetooth, Mobile Data, and VPN. Enter your phone's Wi-Fi settings and click Wi-Fi to search for the Wi-Fi of the drone. (Make sure to turn on the drone before going to the Wi-Fi settings on your phone)
 - ② Select the Wi-Fi network: **HolyStoneEIS-*******.
 - ③ Wait for a couple of seconds for your phone to connect to the drone's Wi-Fi.
 - ④ Enter the **Ophelia GO** application.
- > The connection between your phone and the drone is established automatically.

Attention: The Wi-Fi network created by the drone does not access the Internet.



All of the operations shown in this manual are demonstrated using **MODE 2**.

• Pre-Flight Checklist

1. Make sure the mobile device, and the drone battery are fully charged.
2. Make sure the drone battery and the propellers are mounted securely.
3. Make sure the drone arms are unfolded.
4. Make sure the camera are functioning normally.
5. Make sure that there is nothing obstructing the motors and that they are functioning normally.

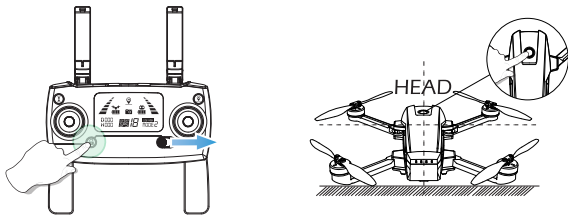
9.3 Pairing



- ① Simultaneously hold the “” button and slide the power switch to the right to power on the transmitter. It will beep 2 times and the signal icon “” will keep flashing.
- ② Long press the Power Switch to turn on the drone, and place it on a level surface with the head forward.
- ③ Once the transmitter sends out a long beep sound and the signal icon “” is shown on the LCD screen, it means that the drone has been successfully paired with the transmitter.

9.4 Initialization Detection

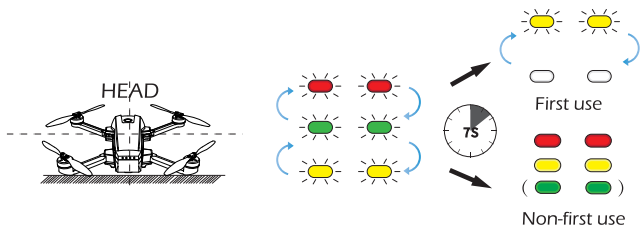

Place the drone on the level surface and it will enter the Initialization Detection. The red, green and yellow lights of the drone will alternate flickering for about **7 seconds** to complete the initial detection. When the transmitter sends out "Di Di", the drone can be divided into two states:

- **First use:** the indicator lights turn yellow and flash alternately.
- **Non-first use:** the indicator lights change to the front red lights and the rear yellow (green) lights.

9.5 Calibrating the Compass

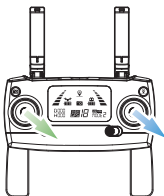

Step 1: As shown in the figure above, push both of the joysticks down to the bottom right at the same time to enter the compass calibration.

When the “✖” icon appears on the LCD screen in the state of slow flashing and the indicator lights turn yellow alternately, it indicates that the drone can start compass calibration.

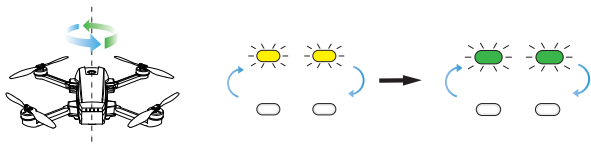

Step 2: Hold the drone horizontally and rotate the drone in 3 complete circles. When completed the green lights will flash.

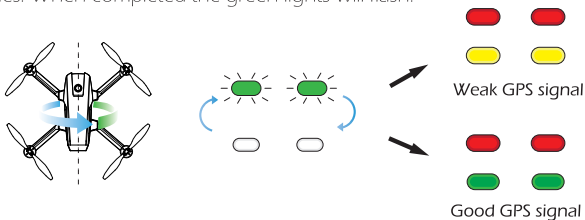

Step 3: Hold the drone vertically and rotate the drone in 3 complete circles. When completed the front red lights and rear yellow lights will turn solid and “✖” on the LCD screen changes from slow flash to disappear.

Attention:

- To ensure a stable flight, we recommend that pilots perform a compass calibration before each flight.
- DO NOT calibrate the compass in locations where magnetic interference may occur, such as close to magnetite deposits or large metallic structures such as parking structures, steel reinforced basements, bridges, cars, or scaffolding.
- DO NOT carry objects (such as mobile phones) that contain ferromagnetic materials near the drone during calibration.

9.6 Unlocking

9.6.1 Unlocking the Motor

Please unlock the motor before takeoff.

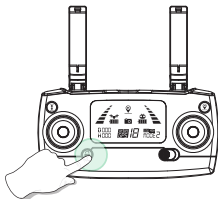

Short press the red button “”. The motors rotate and the drone is unlocked.

9.6.2 Locking the Motor

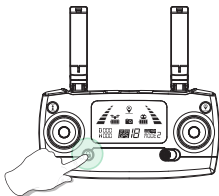

Pic. 7





Pic. 8

Method 1: Long press the red button “” for 3 seconds, the motors will stop rotating immediately and the drone locks. (Pic.7)

Method 2: After drone lands pull the left joystick to the bottom position and hold for 3 seconds. The motor will stop rotating and the drone will be locked. (Pic.8)

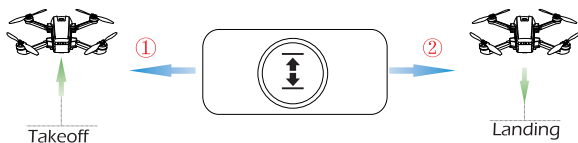
9.7 One Key Takeoff/Landing



① After unlocking the drone, short press the “” button, the drone will automatically take off and hover at 5 feet altitude.

② When the drone is flying, short press the “” button, the drone will automatically land on the ground.

Tips:

Before flying, make sure the GPS Mode is turned on in case the drone gets lost!

10.0 FUNCTION DETAILS

10.1 Camera Angle Adjustment

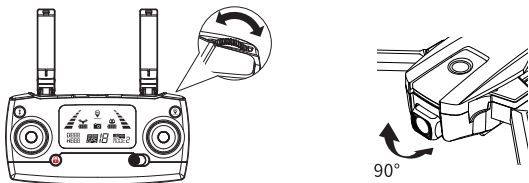

During the flight, you can dial the wheel left/right to tilt the camera up/down.

(The camera has an 90° tilt range.)

10.2 Return to Home (RTH)

- The Return to Home function brings the drone back to the last recorded Home Point.
 - The Home Point is the location at which the drone takes off or the GPS receives a signal from 7 or more satellites for the first time during flight. The current position of the drone will be recorded as the Home Point.
-

10.2.1 Smart RTH

If the GPS signal is available (7 or more satellites reception) and the home point is recorded previously, press the “” button on the transmitter, then the drone will fly back to the Home Point.

Exit the RTH mode by pressing the “” button again or pushing the Throttle Joystick .

10.2.2 Failsafe RTH

If the GPS signal is available (at least 7 satellites) and the home point is recorded previously. Failsafe Return will be triggered if the transmitter signal is lost for more than 6 seconds. The drone will automatically start the return procedure and it will fly back to the last recorded Home Point. You can exit “Failsafe RTH” mode by pressing the “” button or pushing the left joystick up or down if the transmitter signal is recovered.



- During the Failsafe Return procedure, the drone can not avoid obstacles.
- The drone cannot Return-to-Home if the GPS signal is weak (satellites number is less than 7).
- If there is no GPS signal or the transmitter signal has lost for more than 6 seconds, the drone will not Return-to-Home but it can descend slowly until landing on the ground and locking the drone.

10.2.3 Low Voltage RTH

① When the drone's rear lights flash slowly, the “” symbol is displayed on the screen of the transmitter, the First Low Voltage RTH will be triggered. And the drone will return automatically in the following two conditions: (At this time, the drone can only fly within a safe range of the height no more than 98 feet and the distance no more than 328 feet.)

a. When the flight altitude is higher than 98 feet, the drone will fly back above the Home Point then descend automatically to 98 feet high and exit the First Low Voltage RTH.

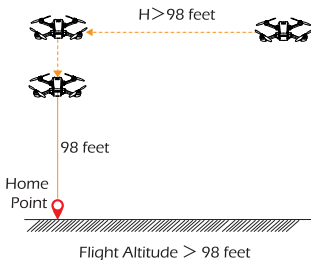

b. When the flight altitude is lower than 98 feet, the drone will elevate automatically to 98 feet high then fly back above the Home Point and exit the First Low Voltage RTH.

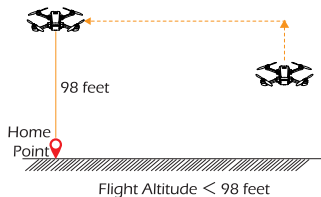

② If the drone's rear lights begin to flash rapidly the “” symbol will be displayed on the transmitter screen and the transmitter will emit a “Di..., Di...” alert. The Second Low Voltage RTH is automatically triggered.

a. When the flight altitude is higher than or equal to 50 feet, the drone will stay in the current altitude and return above the Home Point then descend vertically.

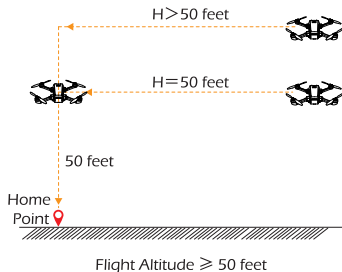

b. When the flight altitude is lower than 50 feet, the drone will elevate automatically to 50 feet high then fly back above the Home Point and descend vertically.

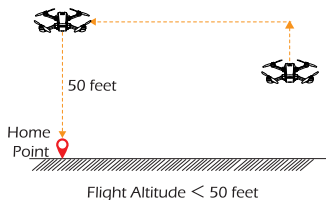

10.3 Optical Flow Positioning

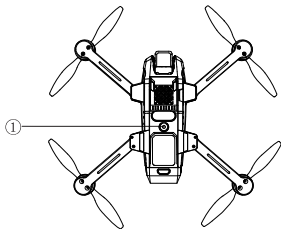

The Optical Flow Positioning System consists of a camera ① module, which acquires the position information of the drone through visual images to ensure precise positioning of the drone.

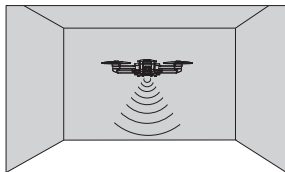

The Optical Flow Positioning System is typically used in indoor environment when GPS is weak or unavailable. It works best when the drone altitude is less than 3 meters.

When in a dark environment, you can turn on the lights by pressing the Light Switch button “☀” in the upper right corner of the transmitter to facilitate the image positioning function.



The precision of the Optical Flow Positioning System is easily affected by the light strength and features of the surface textures. Once the image sensor

is not available, your drone will switch to Gesture Mode automatically. Be cautious to operate the drone in the following situation:

1. Fly fast at an altitude below 0.5m.
2. Fly over monochrome surfaces (like pure black, pure red, pure red and pure green).
3. Fly over strong light reflective surfaces or surfaces prone to reflection.
4. Fly over water or transparent object surfaces.
5. Fly over moving object surfaces (such as crowds, swaying juggles and glass).
6. Fly over an area where light changes dramatically and rapidly.
7. Fly over surfaces extremely dark ($\text{lux} < 10$) or extremely bright ($\text{lux} > 10,000$).
8. Fly over surfaces without clear textures.
9. Fly over surfaces with highly repeating textures (small grid brick in the same color).
10. Fly over surfaces that are tilting over 30 degrees (could not receive the echo of the ultrasonic wave).
11. Flying speed should be controlled not to be too fast. When drone is 1 meter from the ground, the flying speed should not be over 5m/s. When the drone is 2 meter against the ground, the flying speed should not be over 10m/s.

- Keep sensors clean at all times.
- The vision system is only effective when the drone is within the altitude range of 3 meters.
- Make sure that the light is bright enough and the surfaces is with clear textures so that the vision system can acquire the movement information through recognizing the ground textures.
- The vision system may not function properly when the drone is flying over water, low light ground and surfaces without clear patterns or textures.

11.0 APP OPERATION INSTRUCTION

11.1 Operation Interface

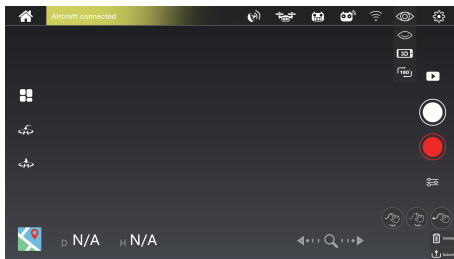

Homepage



GPS Signal



Drone
Battery Level



Transmitter
Battery Level



Transmitter
Signal Strength



Signal
Strength



Hide
On/ Off

3D VR

180° Screen
Rotation



General Settings



Follow Me



Point of
Interest



Headless
Mode



RTH Switch



One Key Takeoff/
Landing



Gallery



Take
Photo



Record
Video



Camera
Parameters



TapFly



Delete



Submit



Distance
(m)



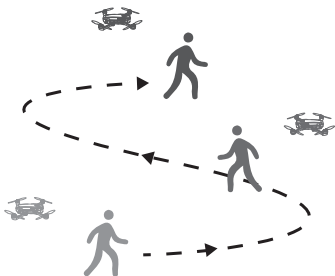

Height
(m)

11.2 Follow Me



When the Follow Me function is enabled, the drone will follow the GPS in your smart phone to follow you wherever you go.



1. Ensure the drone's flight range is within 15~95 feet.
2. Click the “” icon first, then select the “” icon, and follow the prompt box to enter the Follow Me function — the drone will now follow the phone's coordinates.
3. To exit Follow Me Mode, simply click the “” icon on the app interface again.

Common Issues:

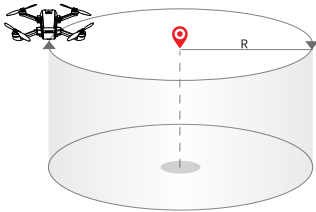

- ① The Follow Me function can only be used if the flight range is within 15~95 feet.
- ② Follow Me mode may be difficult to activate if the phone's GPS signal is too weak. This could be due to the signal loss from surrounding buildings, trees, or congestion from too many mobile phones in the area.
- ③ Use in an open area and be mindful of your surroundings. The drone is NOT equipped with obstacle avoidance.

1 1.3 Point of Interest



1. Click the “” icon first, then select the “” icon, and follow the prompt box to enter the Point of Interest function.
2. The drone will record its flight position the moment you enter this function as the point of interest. The drone will now continuously circle clockwise around the preset point. (The default radius is 16 feet.)
3. To exit Point of Interest mode, simply click the “” icon on the application interface again.

11.4 Headless Mode

- ① Click the “” icon first, then select the “” icon, and follow the prompt box to enter the Headless Mode.
- ② Exit the Headless Mode by clicking the “” icon again.

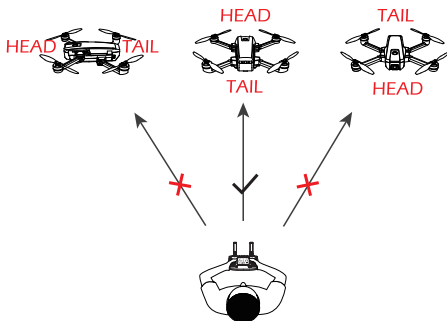

Please make the pilot stays facing the same direction as the direction that the head of the drone faces at takeoff.

While in Headless Mode, pushing the direction joystick forward will make it fly in the direction that the head of the drone faces when it takes off.

To make sure that the pilot can tell drone's direction, during the flight, we recommend that the pilot stays facing the same direction that the drone head faces at take-off.



By doing so it is ensured that when the pilot pushes the direction joystick forward/backward, the drone will fly forward/backward toward him/her. If the pilot moves the direction joystick left/right, the drone will move left/right relative to him/her.

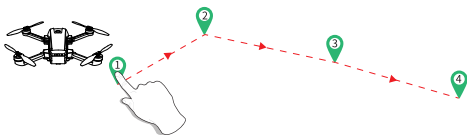

11.5 TapFly

It is recommended to enlarge the map if you want to use TapFly.



1. Please click on the Map first, then click the “” icon, and follow the prompt box to enter the TapFly function.

MODE 1: Click the “” icon on the app interface, draw a line on the screen to create a path, click “” icon to submit the route, and the drone will fly along the path.

MODE 2: Click the “” icon on the app interface, set any point on the screen, click “” icon to submit the route. The drone will now fly along the path according to the points connected on the map.

2. Exit the TapFly mode by clicking the “” icon again.



3. If the flight path submission fails, you can choose to re-submit or exit again.









- DO NOT fly the drone towards people, animals, or small/ fine objects (e.g. tree branches and power lines) or transparent objects (e.g. glass or water).

- There may be some deviation between the expected and actual flight path.

11.6 Take Photo/Video

- ① Click the “” icon to take photo, click once to take a photo.
- ② Click the “” icon to record video, click once to start recording, and click again to stop recording.
- ③ Click the “” icon to enter the gallery for viewing.
- ④ Without the TF card installed, the photos and videos will be saved in app albums.
- ⑤ After installing the TF card, the photos and videos will be saved in both the app album and the TF card.
- ⑥ If you want to view the photos and videos stored in the TF card in the application, please make sure that the phone is connected to the Wi-Fi of the drone.

12.0 DRONE STATUS INDICATOR

Indicator Status	Meanings
 <p>Front and rear lights alternate flashing yellow.</p>	<p>The drone is not connected to the transmitter.</p>
 <p>Red, green and yellow lights flashing and alternate.</p>	<p>Drone is currently in Initialization Detection status.</p>
 <p>Front light turns solid red, rear light turns solid yellow.</p>	<p>No GPS signal or weak GPS signal.</p>
 <p>Front light turns solid red, rear light turns solid green.</p>	<p>Good GPS signal.</p>
 <p>Front and rear lights alternate flashing green.</p>	<p>Compass Horizontal Calibration has completed.</p>
 <p>Front light turns solid red, rear light flashes red slowly.</p>	<p>Entering the First Low Voltage RTH.</p>
 <p>Front light turns solid red, rear light flashes red rapidly.</p>	<p>Entering the Second Low Voltage RTH.</p>

13.0 SPECIFICATIONS

DRONE

Model: HS720E

Weight: 495g/17.46oz

Max Flight Time: 23 minutes (per battery)

Operating Temperature Range: 32° to 104°F

Size: 177 x 104 x 58 mm (Folded)

337 x 240 x 58 mm (Unfolded)

DRONE BATTERY

Capacity: 2800 mAh

Voltage: 7.4 V

Battery Type: Lithium-ion Polymer Battery

Energy: 20.72 Wh

Charging Temperature Range: 41° to 104°F (5° to 40°C)

Charging Time: about 5 hours

TRANSMITTER

Operating Frequency: 2452-2474 MHz

Transmitter Power (EIRP): <16 dBm

Max Flight Distance: 3277 feet/999m (outdoor and unobstructed)

Battery Type: 2×1.5V AA batteries (Not included)

Operating Temperature Range: 32° to 104°F

CAMERA

Operating Frequency: 5500-5700 MHz

Photo Resolution: 3840×2160P (stored in TF card)

1920×1080P (stored on mobile phone)

Video Resolution: 3840×2160P (stored in TF card)

1280×720P (stored on mobile phone)

Lens: FOV 130°

Max Transmission Distance: 1640 feet/500m (outdoor and
unobstructed)

Live View Quality: 4K@30fps/1080P@60fps

Photo Formats: JPEG

Video Formats: AV/MP4

Memory Card Tape: Supports a TF Card (Class 10 above) with
capacity of up to 128 GB (Not included)

File System: FAT32

Controllable Range: Pitch: -90° to 0°

Operating Temperature Range: 32° to 104°F

USB CHARGING CABLE

Input: 5 V/2A

Rated Power: ≤10 W

14.0 TROUBLE SHOOTING

No.	Problem	Solution
1	When the drone is powered on, the indicator light keeps flashing rapidly.	The drone is in the gyroscope calibration state. Please place the drone on an flat and level surface.
2	The drone cannot hover after takeoff and tilts to one side.	Place the drone on a flat, level surface and repeat the gyro calibration.
3	The drone vibrated in flight.	The propeller are damaged. Please replace the new propeller.
4	The drone could not be unlocked and the rear light flashed.	The drone battery voltage is too low. Please fully charge the battery.

15.0 CONTACT US

Please do not hesitate to contact us if you need further support.

 4:00 PM ~ 7:00 AM (PST)

 usa@holystone.com (America)
ca@holystone.com (Canada)
eu@holystone.com (Europe)
es@holystone.com (España)

 +1(855) 888-6699



For online support, please scan this code with Live Chat

16.0 GENERAL INFORMATION

FCC Statement:

This device complies with part 15 of the FCC Rules. Operation is subject to the following two conditions:

- (1) This device may not cause harmful interference, and
- (2) This device must accept any interference received, including interference that may cause undesired operation.

The Supplier's Declaration of Conformity is available at the following address:

https://www.holystone.com/Download/US/HS720E_FCC_sDoC.pdf

NOTE: This equipment has been tested and found to comply with the limits for a Class B digital device, pursuant to Part 15 of the FCC Rules. These limits are designed to provide reasonable protection against harmful interference in a residential installation. This equipment generates uses and can radiate radio frequency energy and, if not installed and used in accordance with the instructions, may cause harmful interference to radio communications. However, there is no guarantee that interference will not occur in a particular installation. If this equipment does cause harmful interference to radio or television reception, which can be determined by turning the equipment off and on, the user is encouraged to try to correct the interference by one or more of the following measures:

- Reorient or relocate the receiving antenna.
- Increase the separation between the equipment and receiver.
- Connect the equipment into an outlet on a circuit different from that to which the receiver is connected.
- Consult the dealer or an experienced radio/TV technician for help.

WARNING: Changes or modifications not expressly approved by the party responsible for compliance could void the user's authority to operate the equipment.

RF Exposure

The equipment complies with FCC radiation exposure limits set forth for an uncontrolled environment. This device should be installed and operated with minimum distance 20cm between the radiator & your body. This part belongs to the drone.

RF warning for Portable device: The device has been evaluated to meet general RF exposure requirement. The device can be used in portable exposure condition without restriction. This part belongs to the transmitter.

IC Notice:

This device is restricted to indoor use when operating in the 5150 to 5250 MHz frequency range.

This device complies with Canada Industry licence-exempt RSS standard(s).

Operation is subject to the following two conditions:

- (1) this device may not cause interference; and
- (2) this device must accept any interference. Including interference that may cause undesired operation of the device.

CAN ICES-003 (B)

Avis d'Industrie Canada

Le présent appareil est conforme aux CNR d'industrie Canada applicables aux appareils radio exempts de licence L'exploitation est autorisée aux deux conditions suivantes:

- 1) l'appareil ne doit pas produire de brouillage; et

2) l'utilisateur de l'appareil doit accepter brouillage radioélectrique subi même si le brouillage est susceptible d'en compromettre le fonctionnement. mauvais fonctionnement de l'appareil. Cet appareil numérique de la classe B est conforme à la norme NMB-003 du Canada.

CAN NMB-003 (B)

RF Exposure

Radiation Exposure Statement:

This equipment complies with IC radiation exposure limits set forth for an uncontrolled environment. This equipment should be installed and operated with minimum distance 20cm between the radiator & your body.

Déclaration d'exposition aux radiations:

Cet équipement est conforme aux limites d'exposition aux rayonnements IC établies pour un environnement non contrôlé. Cet équipement doit être installé et utilisé avec un minimum de 20 cm de distance entre la source de rayonnement et votre corps.

HOW TO RECYCLE THIS PRODUCT

This symbol on the product or its documentation indicates that it must not be disposed of with household waste.

Uncontrolled waste disposal may harm the environment or human health. Please separate your device from other types of waste to recycle it responsibly.

This will help to foster the sustainable re-use of material resources.

We invite you to contact your retailer or inquire at your local town hall to find out where and how the drone can be recycled.

BATTERY WARNING:

1. Failure to follow all the instructions may result in serious injury, irreparable damage to the battery and may cause a fire, smoke or explosion.
2. Always check the battery's condition before charging or using it.
3. Replace the battery if it has been dropped, or in case of odor, overheating, discolouration, deformation or leakage.
4. Never use anything other than the approval LiPo charger the battery. Always use a balancing charger for LiPo cells or a LiPo cell balancer. It is recommended that you do not to use any other charger than the one provided with the product.
5. The battery temperature must never exceed 60°C (140°F) otherwise the battery could be damaged or ignite.
6. Never charge battery on a flammable surface, near flammable products or inside a vehicle (preferably place the battery in a non-flammable and nonconductive container).
7. Never leave the battery unattended during the charging process. Never disassemble or modify the housing's wiring, or puncture the cells. Always ensure that the charger output voltage corresponds to the voltage of the battery. Do not short circuit the batteries.
8. Never expose the LiPo battery to moisture or direct sunlight, or store it in a place where temperatures could exceed 60°C (car in the sun, for example).
9. Always keep it out of reach of children.
10. Improper battery use may result in a fire, explosion or other hazard.



11. Non-rechargeable batteries are not to be recharged. Rechargeable batteries are only to be charged under adult supervision.
12. Different types of batteries or new and used batteries are not to be mixed.
13. Batteries are to be inserted with the correct polarity.
14. The supply terminals are not to be short-circuited. Regular examination of transformer or battery charger for any damage to their cord, plug, enclosure and other parts and they must not be used until the damage has been repaired.
15. The packaging has to be kept since it contains important information.
16. The toy is only to be connected to Class II equipment bearing the symbol. 

EU RF Power(EIRP): <16 dBm (2452MHz ~ 2474 MHz)

Caution

1. The max operating of the EUT is 45°C. and shouldn't be lower than -10°C.
2. The device complies with RF specifications when the device used at 0mm from your body.
3. Declaration of Conformity.

We, Xiamen Huoshiquan Import & Export CO., LTD hereby, declare that the essential requirements compliance with the Directive 2014/53/EU, the RoHS Directive 2011/65/EU and Safety Directive 2009/48/EC have been fully fulfilled on our product with indication below:

Product Name: REMOTE CONTROL MODEL/RADIO CONTROLLED
Model/Mark: HS720E/HOLYSTONE

The Statement of compliance is available at the following address:
http://www.holystone.com/Download/CE/HS720E_EU_DOC.pdf
This product can be used across EU member states.

MANUFACTURER INFORMATION

Manufactured by

Xiamen Huoshiquan Import & Export CO.,LTD

Unit 1, Room 501, Hongxiang Building, No.258 Hubin Nan Road, Siming District, Xiamen, China

+1(855) 888-6699



FAA REGISTRATION: PLEASE FOLLOW ALL FEDERAL, STATE AND LOCAL FAA LAWS. YOU MAY BE REQUIRED TO REGISTER YOURSELF AND YOUR DRONE WITH THE FAA MORE INFO CAN BE FOUND AT: [HTTPS://WWW.FAA.GOV/UAS/GETTING STARTED/](https://www.faa.gov/uas/getting-started/)

After receiving the certificate of registration, you must mark your **unique FAA registration number** on the Drone by any means, such as permanent marker, label, engraving. This number must be readily accessible and maintained in a condition that is readable and legible upon close visual inspection

WARNING: Do **NOT** fly drone near airports or any other un-authorized areas. Follow all rules for Federal Aviation Administration (FAA) regulation summary for Small Unmanned Aircraft Systems (sUAS).

Read: Academy of Model Aeronautics (AMA) Know Before You Fly important information brochure.



MADE IN CHINA(CN)