



14+
ages

Instructions For Use

Gebrauchsanweisung

V4.0

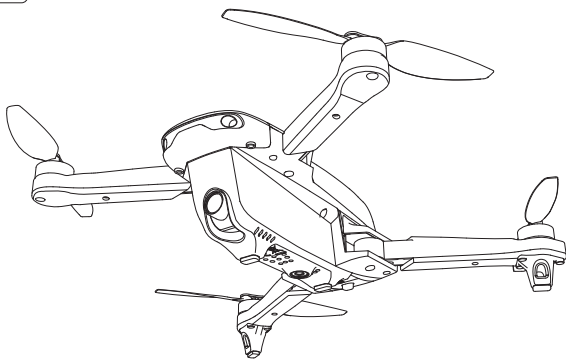

HS175D

 +1(855) 888-6699

 www.holystone.com

 usa@holystone.com (USA)
ca@holystone.com (CA)

eu@holystone.com (EU)

English

01-36

Deutsch

37-70

Contents

1.0 Disclaimer & Warning	01
2.0 Safety Guidelines	01
3.0 Maintenance	05
4.0 Package Contents	06
5.0 Drone Details	07
6.0 Transmitter Details	08
7.0 Mode Switch	09
8.0 Installation	
8.1 Propellers	10
8.2 TF Card	10
8.3 Drone Battery	11
8.4 Antenna	11
9.0 Charging	
9.1 Drone Battery	12
9.2 Transmitter Battery	13
10.0 Operation Guide	
10.1 Download APP	14
10.2 Connect to Wi-Fi	14
10.3 Pairing	15
10.4 Calibrating the Compass	16
10.5 GPS Searching	17
10.6 Calibrating the Gyro	18
10.7 Unlocking the Motor	18
10.8 One Key Takeoff/Landing	19
10.9 Drone Status Indicator States	19

11.0 Functions Details	
11.1 Camera Angle Adjustment	20
11.2 Speed Switch	20
11.3 Trimmer Function	21
11.4 Take Photo/Video	22
11.5 Headless Mode	23
11.6 Return to Home (RTH)	24
11.7 Emergency Stop	25
11.8 Optical Flow Positioning	26
12.0 Specifications	28
13.0 Trouble Shooting	30
14.0 Contact Us	30
15.0 General Information	31

1.0 DISCLAIMER & WARNING

1. Please read this Disclaimer & Warning and Safety Guidelines carefully before using our product. This product is not recommended for people under the age of 14. By using this product, you hereby agree to this disclaimer and signify that you have read it fully. You agree that you are responsible for your own conduct and any damages caused while using this product, and its consequences. You agree to only use this product for its designed purposes and in accordance with local laws, regulations and all applicable policies and guidelines that HolyStone may provide.

2. When using this product, please be sure to strictly abide by the specification requirements and safety guidelines stated in this document. Any personal injury, property damage, legal disputes and all other adverse events caused by the violation of any of the safety instructions or due to any other factor, WILL NOT be HolyStone's responsibility.

2.0 SAFETY GUIDELINES

2.1 Check Before Use

- ① This product is a high precision drone that integrates various electronic stability and control mechanisms. Please be sure to configure this drone carefully and correctly to ensure safe, accident-free operation.
- ② Ensure that the batteries of the drone and transmitter are clean, undamaged and fully charged before every use.
- ③ Ensure that all the propellers are undamaged and are installed in the correct orientation.

④ Please perform a thorough check of the product before each use. Inspect the integrity of the parts, any signs of cracks and wear off on the propellers, battery power and effectiveness of the indicator, etc. If after doing a complete check of the drone any problems are found, please refrain from using it until the problem has been resolved.

2.2 Flight Environment



Avoid flying over or near obstacles, crowds, high voltage power lines, trees, airport or bodies of water.

DO NOT fly near strong electromagnetic sources such as power lines and base stations as it may affect the onboard compass.



DO NOT use this drone in adverse weather conditions such as rain, snow, fog, and wind.

2.3 Operation Requirements

- ① DO NOT use this product to follow any moving vehicles.
- ② During the flight, turn off the motors only in case of an emergency.
- ③ Fly the drone back to you as soon as you are notified that the battery is running low.
- ④ This product should not be used while drinking alcohol or consuming drugs, if you are feeling fatigued, taking medicine, or feeling any physical discomfort.
- ⑤ Be aware of the volume of noise that the drone produces. Please ensure to keep your distance to avoid ear damage.





- ⑥ **Stay away from the rotating propellers and motors.**

- ⑦ **DO NOT fly in any spaces where drones are prohibited. Please respect people's right to privacy by not flying your drone close to others.**

2.4 Use of Battery

- ① Please ensure batteries are fitted in the correct orientation as shown in the instruction manual.
- ② Avoid short circuits by fitting the batteries correctly, and do not crush or squeeze the batteries as this could cause the risk of a fire or explosion.
- ③ DO NOT mix new and old batteries as this can lead to a poor performance of the product.
- ④ Please dispose of used batteries carefully, do not litter and recycle where ever possible.
- ⑤ DO NOT expose dead batteries to heat or fire or they may explode.
- ⑥ If the device is not going to be used for an extended period of time, please remove batteries to prevent potential damage from to the drone battery leakage.





- ⑦ Only use the USB charging cable that comes with the drone to charge the battery.
- ⑧ DO NOT connect the battery directly to wall outlets or car cigarette lighter sockets as this will damage your battery as they are a different voltage.
- ⑨ DO NOT attempt to disassemble or modify the battery in any way
- ⑩ DO NOT use the battery if it gives off an odor, generates heat, becomes discolored, deformed or appears abnormal in any way. If any of these situations occur while the battery is in use or being charged, remove it from the device or charger immediately and discontinue use.
- ⑪ DO NOT pierce the battery casing with a nail or any other sharp object, break it open with a hammer, or step on it! Dispose or recycle this battery as it may cause personal injury or damage to your drone.
- ⑫ Always charge the batteries on a fireproof surface and away from combustible materials. DO NOT charge on surfaces that can catch fire. This includes: wood, cloth, carpet, or on the application's device.
- ⑬ DO NOT immerse the battery in water or get it wet.
- ⑭ DO NOT solder battery terminal in any way.
- ⑮ Keep batteries out of reach of children or pets.
- ⑯ DO NOT short-circuit the battery by connecting wires or any other metal object to the positive(+) and negative(-) terminals.

	Li-Po Battery Disposal & Recycling	
Waste Lithium-polymer batteries must not be placed with household trash. Please contact local environmental or waste agency or the waste agency or the supplier of your model or your nearest Li-Po battery recycling center.		

3.0 MAINTENANCE

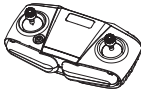
- ① Clean the product after each use with a clean, soft cloth.
- ② Avoid prolonged exposure to direct sunlight and avoid buildup of heat on the drone or batteries.
- ③ This device is not waterproof and must not be submerged or subjected in water under any circumstance. Failure to keep the device completely dry will result in the failure and permanent damage to the unit. Be aware that although it might be dry where you are, droplets of rain or mist from a river or waterfall could be damaging your drone where it is flying.
- ④ Frequently check the charging plug and other accessories for signs of damage. If any part of the device or cables are damaged, avoid use or charging until the device can be serviced.

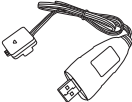
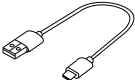
4.0 PACKAGE CONTENTS

		
<p>Drone</p>	<p>Transmitter</p>	<p>Drone Battery</p>
		
<p>Propeller</p>	<p>USB Charging Cable for Drone</p>	<p>USB Charging Cable for Transmitter</p>
		
<p>Screwdriver</p>	<p>Instructions For Use</p>	

5.0 DRONE DETAILS

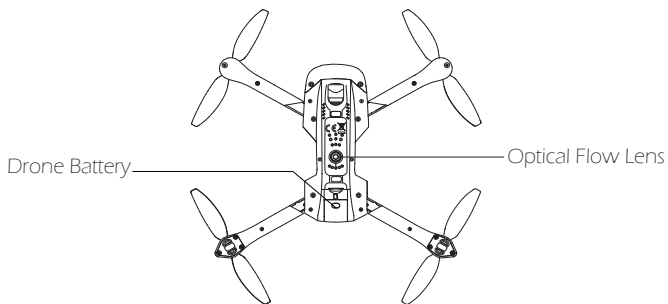
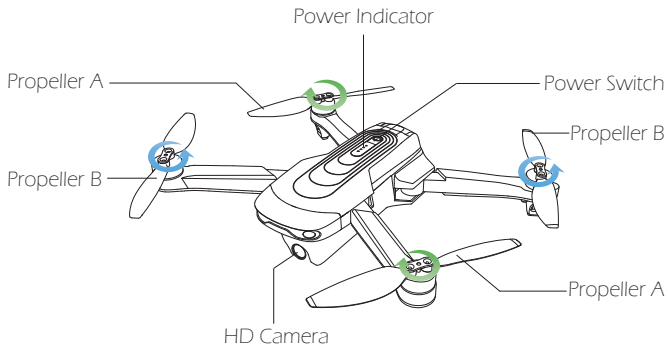

6.0 TRANSMITTER DETAILS

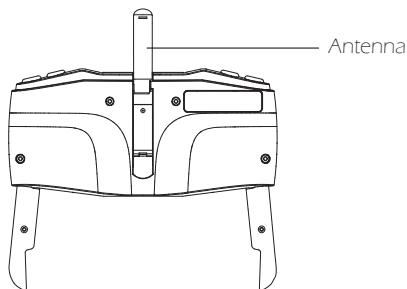
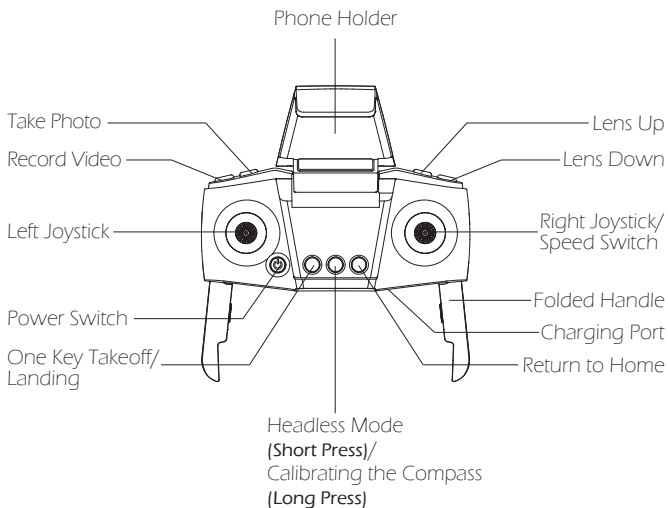

7.0 MODE SWITCH

7.1 MODE 2 (Left hand throttle MODE 2 will be default setting.)

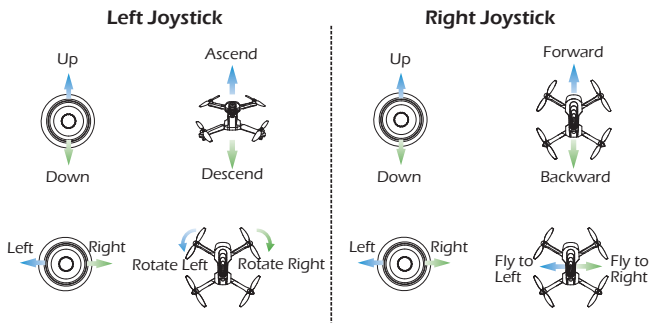

7.2 MODE 1

To enter MODE 1, turn on the transmitter while holding the “Record Video” button. (Please do not release the “Record Video” button until the transmitter is powered on.)

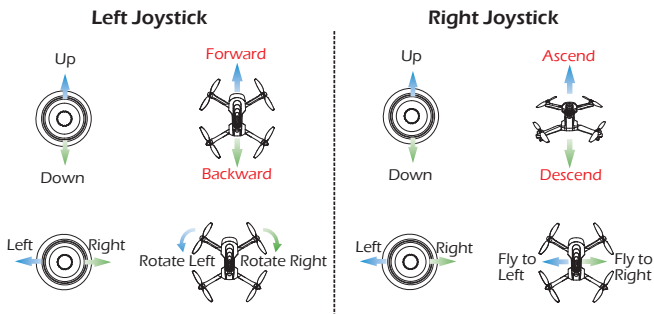

8.0 INSTALLATION

8.1 Propellers

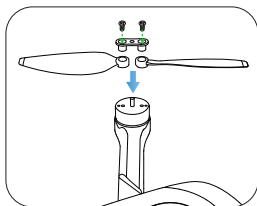
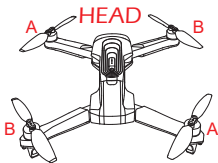

Connect each propeller to its corresponding motor shaft, either position "A/B", then lock the propeller to the motor shaft with two screws.

Attention: Pay attention to the "A" or "B" is printed on the each propeller. The drone will not fly unless the correct propeller is installed on the correct motor shaft.

8.2 TF Card

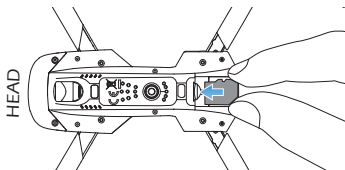

To store your photos and videos, insert the TF card (not included) into the slot as shown above before turning on the drone. The drone supports TF card up to 64 GB.

8.3 Drone Battery

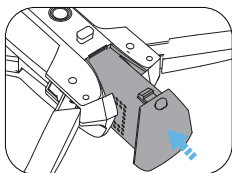

Pic.1

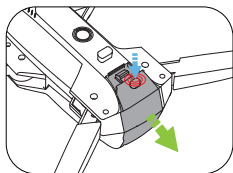

Pic.2

Installation: Push the battery correctly into the drone battery compartment. Make sure that you hear a click sound indicating the battery is firmly installed. (Pic.1)

Removal: Press the lock button on the battery and pull it back to remove the battery from the fuselage. (Pic.2)

Attention: The battery should be installed firmly, failure to do so may affect the flight safety of your drone. The drone may crash due to power-cut during the flight.

8.4 Antenna

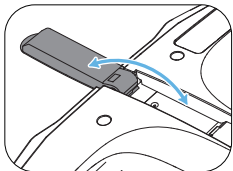
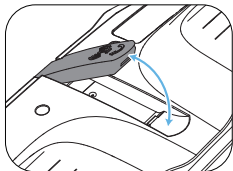

Before flying, please adjust the antenna on the back of the transmitter so it is facing outward.

9.0 CHARGING

9.1 Drone Battery

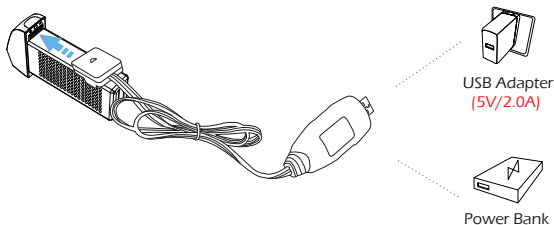

- 1) When the drone battery runs low, the indicator lights on the drone will flash continuously.
- 2) Remove the battery and connect the USB charging cable to the battery charging interface.
- 3) Plug the USB charging cable into a USB charging port on the power bank or USB adapter (5V/2.0A).
- 4) The green indicator light on the USB charging cable will flash slowly when the battery is charging, and will turn solid when the battery is fully charged.
- 5) Charging time: about 150 minutes.



- Before charging, please check the contents of the “Use of Battery” section of the “Safety Guidelines” carefully!
- When the charging fails, the green light on the charging cable will flash quickly.

9.2 Transmitter Battery

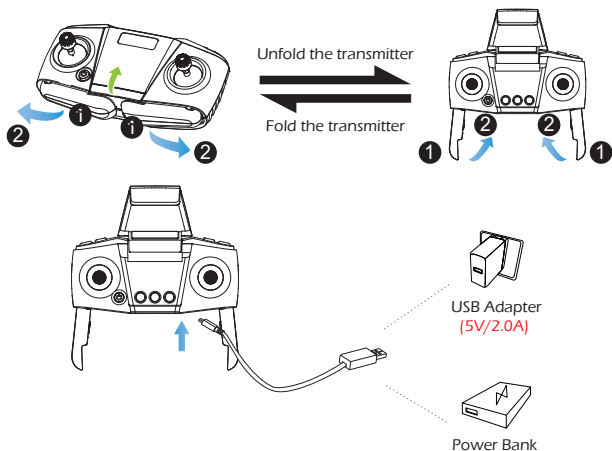

- 1) When the transmitter battery runs low, the transmitter will continue to sound the “DiDiDi...” alarm.
- 2) Connect the USB charging cable to the charging interface.
- 3) Plug the USB charging cable into a USB charging port on power bank or USB adapter (5V/2.0A).
- 4) The red indicator light on the transmitter will turn on when the battery is charging, and will turn off when the battery is fully charged.
- 5) Charging time: about 60 minutes.



· Before charging, please check the contents of the “Use of Battery” section of the “Safety Guidelines” carefully!

10.0 OPERATION GUIDE

10.1 Download APP



iOS



Android APP on Google play

Scan the QR code, corresponding to either App Store™ or Google Play™ Store and download the **HS GPS V5** app for free.

Required Operating Systems: iOS 8.0 or later/Android 5.0 or later

10.2 Connect to Wi-Fi

Connect your phone to the Wi-Fi network created by the drone. You can check the drone's status on the **HS GPS V5** App.

① Make sure to turn off Bluetooth, Mobile Data, and VPN. Enter your phone's Wi-Fi settings and click Wi-Fi to search for the Wi-Fi of the drone. (Make sure to turn on the drone before going to the Wi-Fi settings on your phone)

② Select the Wi-Fi network: **HolyStoneFPV-*******.

③ Wait for a couple of seconds for your phone to connect to the drone's Wi-Fi.

④ Enter the **HS GPS V5** application.

> The connection between your phone and the drone is established automatically.

Attention: Because the Wi-Fi network created by the drone cannot access the Internet, your phone may inform you in various ways, like saying the connection isn't secure, or there is no internet connection, etc. Please ignore these messages. Or, in the case of getting Pop-ups, choose the option that allows you to stay with the current Wi-Fi.

All of the operations shown in this manual are demonstrated using **MODE 2**.

10.3 Pairing

① Long press the power switch to turn on the drone and the indicator lights on the drone begin to flash.

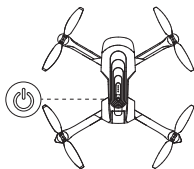

② Place the drone on a flat and level surface with the head forward and the tail towards the pilot.

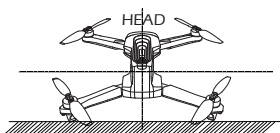

③ Press the power switch on the transmitter to turn it on and you will hear "Di", then the indicator light on the transmitter will flash.

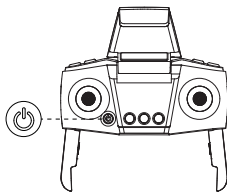

④ Push the left joystick up then down to pair the drone with the transmitter. The indicator lights on the drone and the transmitter will turn solid if the drone is paired successfully.

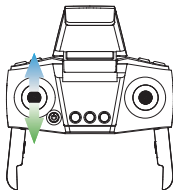

10.4 Calibrating the Compass

① Long press the Compass Calibration button to enter the compass calibration state.

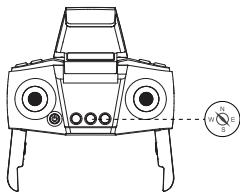

② Hold the drone horizontally and rotate it until the rear indicator lights change from flashing slowly to flashing quickly.

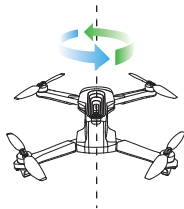

③ Hold the drone vertically and rotate it until the rear indicator lights change from flashing quickly to solid on.

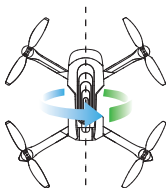

10.5 GPS Searching

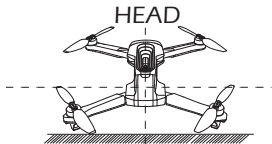

Place the drone on a flat and dry surface where is unobstructed and lit area. When the indicator lights change from red to green, it means that the search for GPS signal is completed. This process may take about one minute.

If the search for GPS signal fails, please repeat all the Compass Calibration operations until the process is successful.

ATTENTION:

- ① The default mode is the GPS Mode. It is highly recommended to operate outdoor flights in GPS mode for maximum safety.
- ② If the GPS signal is weak or flying indoors, please short press the Return to Home button to exit the GPS mode. At this time, the drone is in Optical Flow Mode, and the maximum flying altitude does not exceed 6m.
- ③ The drone will automatically changes to GPS mode when the GPS signal is good. The operator can land and then take off again for a higher altitude.

10.6 Calibrating the Gyro

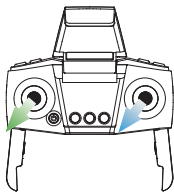

Simultaneously push the left joystick and the right joystick to the bottom left corner to calibrate the gyro.

When the indicator lights on the drone blink quickly and turn solid on, indicating calibration is completed.

Tip: To ensure a stable flight, we suggest that the pilot calibrates the gyro every time after pairing the drone and after a crash.

10.7 Unlocking the Motor

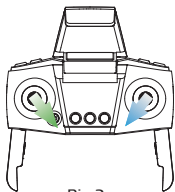

Pic.3

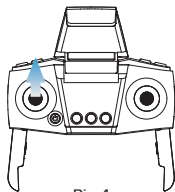

Pic.4

Method 1: Simultaneously push the left joystick to the bottom right corner and the right joystick to the bottom left corner. The motors rotate and the drone is unlocked. (Pic.3)

Method 2: Push the left joystick up, the motors rotate and the drone is unlocked. (Pic.4)

10.8 One Key Takeoff/Landing

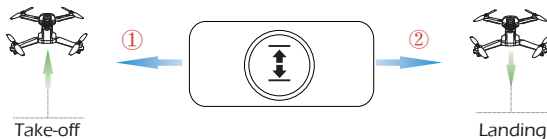

Please unlock the motor before take-off.



① After unlocking the drone, short press the One Key Takeoff button, the drone will automatically take off and hover at 5 feet altitude.

② When the drone is flying, short press the One Key Landing button, the drone will automatically land on the ground.



10.9 Drone Status Indicator States

Color	Action	Drone Status
	Solid Red	Pairing succeeded
	Solid Green	GPS Mode
	Solid Yellow	Optical Flow Mode

11.0 FUNCTION DETAILS

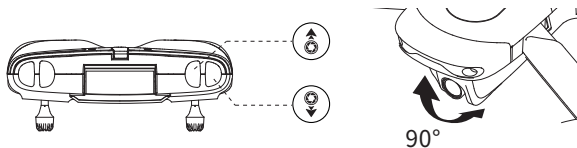
11.1 Camera Angle Adjustment



As shown in the figure above, you can adjust the camera to tilt up or down through the two buttons “” and “”.

(The camera has an 90° tilt range.)

11.2 Speed Switch

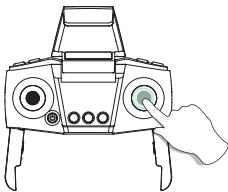

This drone comes with 2 speed modes (Low/High). Press the right joystick down to switch the speed. “Di” indicates Low speed and “Di Di” indicates High speed.

(The Low speed is default speed mode.)

11.3 Trimmer Function

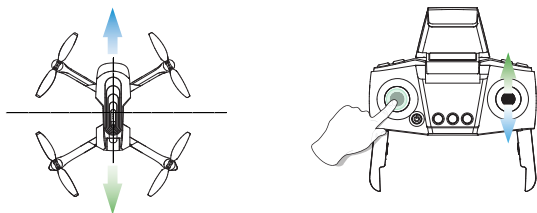

F/B Sideways Drift Trim: If the drone tends to drift forward, press the Throttle joystick and push the Direction joystick down at the same time to re-balance the drone. If the drone tends to drift backward, press the Throttle joystick and push the Direction joystick up at the same time to re-balance the drone.

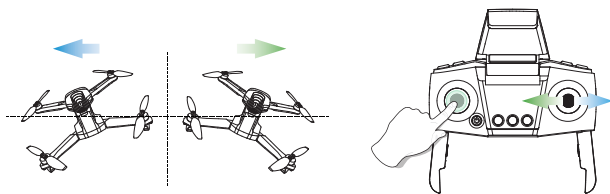

L/R Sideways Dip Trim: If the drone tends to drift left, press the Throttle joystick and push the Direction joystick right at the same time to re-balance the drone. If the drone tends to drift to right, press the Throttle joystick and push the Direction joystick left at the same time to re-balance the drone.

11.4 Take Photo/Video

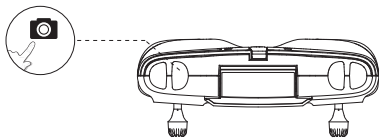

Take Photo: Short press the Photo button on the transmitter to take pictures. One beep can be heard from the transmitter, indicating the camera has successfully taken one photo.

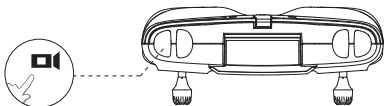

Record Video: Short press the Video button on the transmitter, two beeps from the transmitter will be heard. This tells you that the camera has started recording video. You can exit the recording by pressing the same button again.

- ⚠️ **Do not take photos during the recording, which will interrupt the recording.**
- Without the TF card installed, the photos and videos will be saved in the app albums.
- After installing the TF card, the photos and videos will be saved in both the app album and the TF card.

11.5 Headless Mode

The Headless Mode is a great training tool for beginner pilots. It is also useful when the drone is too far from the pilot (which makes it difficult to tell its orientation). It keeps the drone traveling forward, backward, left, or right when you move the right joystick in those directions, regardless of which way the front of the drone is pointed.

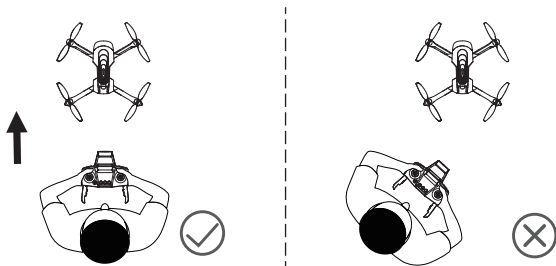

The pilot should stay facing the same direction that the drone's head points to when it is pairing.

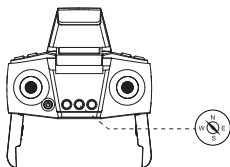

1. Short press the Headless Mode Button to enter the Headless Mode. In Headless Mode, the indicator lights of the drone will flash continuously, and the transmitter will send out beeps continuously.
2. Short press the Headless Mode Button again, and you will hear a beep, the indicator lights on the drone will turn solid which indicates the drone exits the Headless Mode.

11.6 Return to Home (RTH)

The Return to Home (RTH) function brings the drone back to the last recorded take-off point. This function can only be achieved in GPS mode.

There are three types of RTH:

Smart RTH/Low Voltage RTH/Failsafe RTH.

11.6.1 Smart RTH

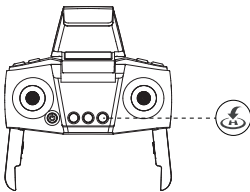

Short press the Return to Home button to enter the return procedure. And you can exit the return procedure by long pressing the Return to Home button again.

- ⚠ · When the flight altitude is lower than 65 feet, the drone will elevate automatically to 65 feet high, and then return home.
- When the flight altitude is higher than 65 feet, the drone will stay in the current altitude and fly back to the take-off point.

11.6.2 Low Voltage RTH

When the drone's indicator lights flash continuously, it means that the battery is in low voltage. The drone will enter the Low Voltage RTH mode and fly back to the take-off point.

- When the flight distance is lower than 65 feet, you can exit Low Voltage RTH.
- When the flight distance is higher than 65 feet, you cannot exit Low Voltage RTH.

11.6.3 Failsafe RTH

If the GPS signal is available and the take-off point is recorded previously. Failsafe RTH will be triggered if the transmitter signal is lost for more than 20 seconds. The drone will automatically start the return procedure and it will fly back to the last recorded take-off point. You can exit Failsafe RTH mode by pressing the Return to Home button if the transmitter signal is recovered.



- During the Failsafe RTH procedure, the drone can not avoid obstacles.
 - The drone cannot Return-to-Home if the GPS signal is weak.
-

11.7 Emergency Stop

- ⚠ The Emergency Stop function can be only used in case of emergency during the flight to avoid any damage or injury.

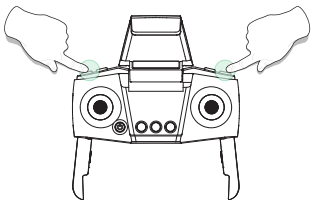

Press and hold the Record Video button and the Lens down button simultaneously for 2 seconds, you will hear 5 beeps from the transmitter, and the drone will fall down immediately. Be aware that you risk breakage of the drone if it falls a large distance or hits anything at a high rate of speed.

11.8 Optical Flow Positioning

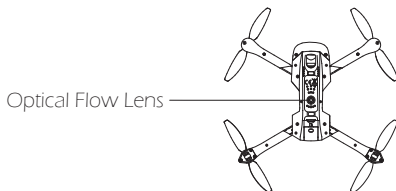

The Optical Flow Positioning System consists of optical flow lens modules, which acquires the position information of the drone through visual images to ensure precise positioning of the drone.

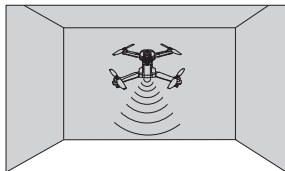

The Optical Flow Positioning System is typically used in indoor environment when GPS is weak or unavailable. It works best when the drone altitude is less than 20 feet/6 meters.



The precision of the Optical Flow Positioning System is easily affected by the light strength and features of the surface textures. Once the image sensor is not available, your drone will switch to Gesture Mode automatically. Be cautious to operate the drone in the following situation:

1. Fly fast at an altitude below 0.5m.
 2. Fly over monochrome surfaces (like pure black, pure red, pure red and pure green).
 3. Fly over strong light reflective surfaces or surfaces prone to reflection.
 4. Fly over water or transparent object surfaces.
 5. Fly over moving object surfaces (such as crowds, swaying juggles and glass).
 6. Fly over an area where light changes dramatically and rapidly.
 7. Fly over surfaces extremely dark ($\text{lux} < 10$) or extremely bright ($\text{lux} > 10,000$).
 8. Fly over surfaces without clear textures.
 9. Fly over surfaces with highly repeating textures (small grid brick in the same color).
 10. Fly over surfaces that are tilting over 30 degrees (could not receive the echo of the ultrasonic wave).
 11. Flying speed should be controlled not to be too fast. When drone is 1 meter from the ground, the flying speed should not be over 5m/s. When the drone is 2 meter against the ground, the flying speed should not be over 10m/s.
- Keep sensors clean at all times.
 - The vision system is only effective when the drone is within the altitude range of 20 feet.
 - Make sure that the light is bright enough and the surfaces is with clear textures so that the vision system can acquire the movement information through recognizing the ground textures.
 - The vision system may not function properly when the drone is flying over water, low light ground and surfaces without clear patterns or textures.

12.0 SPECIFICATIONS

DRONE

Model: HS175D

Weight: 215g/7.58oz

Max Flight Time: 23 minutes (per battery)

Operating Temperature Range: 32° to 104°F

Size: 145 × 65 × 63 mm (Folded)

275 × 210 × 63 mm (Unfolded)

DRONE BATTERY

Capacity: 1700 mAh

Voltage: 7.6 V

Battery Type: Lithium-ion Polymer Battery

Energy: 12.9 Wh

Charging Temperature Range: 41° to 104°F (5° to 40°C)

Charging Time: about 150 minutes

TRANSMITTER

Operating Frequency: 2452-2474MHz

Max Flight Distance: 1640 feet/500m

(outdoor and unobstructed)

Battery Type: 3.7V 380mAh Lithium-ion Polymer battery

Operating Temperature Range: 32° to 104°F

Charging Time: 60 minutes

CAMERA

Operating Frequency: 5500-5700MHz

Photo Resolution: 4096×3072P (stored in TF card)

4096×3072P (stored on mobile phone)

Video Resolution: 2688×1512P (stored in TF card)

1920×1080P (stored on mobile phone)

Lens: FOV 110°

Max Transmission Distance: 984 feet/300m

(outdoor and unobstructed)

Live View Quality: 720p@25fps

Photo Formats: JPEG

Video Formats: AVI/MP4

Supported TF Cards: Supports a TF Card (Class 10 above) with

capacity of up to 64 GB (Not included)

File System: FAT32

Controllable Range: Pitch: -90° to 0°

Operating Temperature Range: 32° to 104°F

USB CHARGING CABLE

Input: 5 V/2 A

Rated Power: ≤10W

13.0 TROUBLE SHOOTING

No.	Problem	Solution
1	The drone does not respond.	1. Charge the drone battery. 2. Charge the transmitter battery.
2	The drone's response is intermittent.	1. Change the batteries. 2. Move to a different area where there is no interference.
3	The drone drifts to one side while hovering.	Place the drone on a flat, level surface and repeat the gyro calibration.
4	The drone does not travel in a forwards direction in headless mode.	Reconfigure the forwards direction.
5	The drone does not hover properly or the drone keeps moving up and down.	1. Repeat the gyro calibration. 2. Avoid flying in poor weather.

14.0 CONTACT US

Please do not hesitate to contact us if you need further support.

 4:00 PM ~ 7:00 AM (PST)

 usa@holystone.com (America)
ca@holystone.com (Canada)
eu@holystone.com (Europe)

 +1(855) 888-6699



For online support, please scan this code with Live Chat

15.0 GENERAL INFORMATION

FCC Notice:

This device complies with Part 15 of the FCC Rules.

Operation is subject to the following two conditions:

- (1) This device may not cause harmful interference.
- (2) This device must accept any interference received, including interference that may cause undesired operation.

The Supplier's Declaration of Conformity is available at the following address:

https://www.holystone.com/Download/US/HS175D_FCC_sDoC.pdf

NOTE: This equipment has been tested and found to comply with the limits for a Class B digital device, pursuant to Part 15 of the FCC Rules. These limits are set to provide reasonable protection against harmful interference in a residential installation. This equipment generates uses and can radiate radio frequency energy, if not installed and used in accordance with the instructions, it may cause harmful interference to radio communications. However, there is no guarantee that interference will not occur in a particular installation. If this equipment does cause harmful interference to radio or television reception, which can not be determined by turning the equipment off and on, the user is encouraged to try one or more of the following measures:

- Reorient or relocate the receiving antenna.
- Separation more distance between the equipment and receiver.
- Connect the equipment to an outlet on a circuit different from the receiver.
- Consult the dealer or an experienced radio/TV technician for help.

WARNING: Changes or modifications not expressly approved by the party responsible for compliance could void the user's authority to operate the equipment.

RF Exposure

The equipment complies with FCC radiation exposure limits set forth for an uncontrolled environment. This device should be installed and operated with a minimum distance of 20cm between the radiator & your body.

IC Notice:

This device is restricted to indoor use when operating in the 5150 to 5250 MHz frequency range.

This device complies with Canada Industry licence-exempt RSS standard(s). Operation is subject to the following two conditions:

- (1) this device may not cause interference; and
- (2) this device must accept any interference. Including interference that may cause undesired operation of the device.

CAN ICES-003 (B)

Avis d'Industrie Canada

Le présent appareil est conforme aux CNR d'industrie Canada applicables aux appareils radio exempts de licence L'exploitation est autorisée aux deux conditions suivantes:

- 1) l'appareil ne doit pas produire de brouillage; et
- 2) l'utilisateur de l'appareil doit accepter brouillage radioélectrique subi même si le brouillage est susceptible d'en compromettre le fonctionnement. mauvais fonctionnement de l'appareil. Cet appareil numérique de la classe B est conforme à la norme NMB-003 du Canada.

CAN NMB-003 (B)

RF Exposure

Radiation Exposure Statement:

This equipment complies with IC radiation exposure limits set forth for an uncontrolled environment. This equipment should be installed and operated with a minimum distance of 20cm between the radiator & your body.

Déclaration d'exposition aux radiations:

Cet équipement est conforme aux limites d'exposition aux rayonnements IC établies pour un environnement non contrôlé. Cet équipement doit être installé et utilisé avec un minimum de 20 cm de distance entre la source de rayonnement et votre corps.

HOW TO RECYCLE THIS PRODUCT

This symbol on the product or its documentation indicates that it **MUST** not be disposed of together with household waste.

Uncontrolled waste disposal may harm the environment or human health. Please separate your device from other types of waste for recycling it responsibly.

This will help to foster the sustainable re-use of material resources.

We suggest you contact your retailer, inquire at your local town hall or business store to find out where and how the drone can be recycled.



BATTERY WARNING:

1. Failure to follow all the instructions may result in serious injury, irreparable damage to the battery may cause a fire, smoke or explosion as well.
2. Always check the battery's condition before charging or using it.
3. Please replace the battery if the battery is dropped or has any peculiar smell, overheating, discolouration, deformation or leakage happens.
4. Never use anything other than the approved LiPo charger to charge the battery. Always use a balancing charger for LiPo cells or a LiPo cell balancer. It is recommended that you use the one provided with the product.
5. The battery temperature must never exceed 60°C (140°F) otherwise the battery could be damaged or ignited.
6. Never charge the battery on a flammable surface, near flammable products or inside a vehicle (preferably place the battery on a non-flammable and non-conductive surface).
7. Never leave the battery unattended during the charging process. Never disassemble or modify the housing's wiring, or puncture the cells. Always ensure that the charger output voltage corresponds to the voltage of the battery. DO NOT short circuit the batteries.
8. Never expose the Li-Po battery to moisture or direct sunlight, or store it in a place where temperatures could exceed 60°C (car in the sun, for example).
9. Always keep it out of reach of children.
10. Improper battery use may result in a fire, explosion or other hazards.
11. Non-rechargeable batteries are not allowed to be recharged. Rechargeable batteries should be charged under adults' supervision.
12. DO NOT mix different types of batteries including the new and used ones.

13. Batteries MUST be inserted with the correct polarity.
14. The supply terminals MUST not to be short-circuited. Regular examination of transformer or battery charger for any damage to their cords, plugs, enclosures and other parts MUST be done. If there is damage, they MUST not be used until the damage has been repaired.
15. The packaging has to be kept since it contains important information.
16. This toy can be only connected to the equipment with symbol Class II.



EU RF Power(EIRP): <16 dBm (2452MHz ~ 2474 MHz)

Caution

- 1.The max operating of the EUT is 45°C, and shouldn't be lower than -10°C.
- 2.The device complies with RF specifications when the device used at 0mm form your body.
- 3.Declaration of Conformity.

We, Xiamen Huoshiquan Import & Export CO.,LTD hereby, declare that the compliance of the essential requirements with the Directive 2014/53/EU, the RoHS Directive 2011/65/EU and Safety Directive 2009/48/EC have been fully fulfilled on our product with indication below:

Product Name: Remote control four axis series

Model/Mark : HS175D/HOLYSTONE

The Statement of compliance is available at the following address:

http://www.holystone.com/Download/CE/HS175D_EU_DOC.pdf

This product can be used among EU member states.

MANUFACTURER INFORMATION

Manufactured by

Xiamen Huoshiquan Import & Export CO.,LTD.

Address: Unit 1, Room 501, Hongxiang Building, No.258 Hubin Nan Road, Siming District, Xiamen, China

+1(855) 888-6699



MADE IN CHINA(CN)