



14+
age

Instructions For Use

Gebrauchsanweisung

V1.0

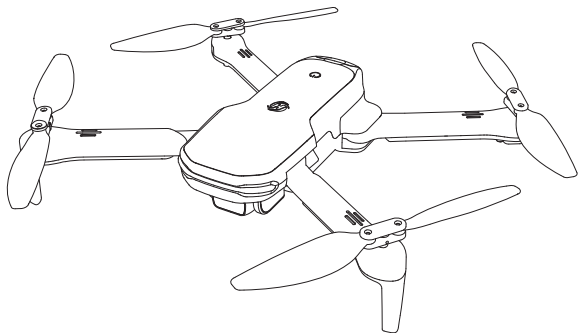

HS280

 +1(855) 888-6699

 www.holystone.com

 usa@holystone.com (USA)
ca@holystone.com (CA)

eu@holystone.com (EU)

English

01-31

Deutsch

32-59

Contents

1.0 Disclaimer & Warning	01
2.0 Safety Guidelines	01
3.0 Maintenance	05
4.0 Package Contents	06
5.0 Drone Details	07
6.0 Transmitter Details	07
7.0 Mode Switch	09
8.0 Installation	
8.1 Propellers	10
8.2 Drone Battery	11
9.0 Charging	12
10.0 Using the App	
10.1 Download App	13
10.2 Connect to Wi-Fi	13
11.0 Operation Guide	
11.1 Pairing	14
11.2 Calibrating the Gyro	15
11.3 Unlocking/Locking the Motors	15
11.4 One Key Takeoff/Landing.....	16
12.0 Functions Details	
12.1 Emergency Stop	17
12.2 Speed Switch	17
12.3 Take Photo/Record Video	18
12.4 Camera Angle Adjustment	18

12.5 Headless Mode	19
12.6 Trimmer	21
12.7 Altitude-Hold Function	22
13.0 Specifications	23
14.0 Contact Us	25
15.0 General Information	26

1.0 DISCLAIMER & WARNING

1. Please read this Disclaimer & Warning and Safety Guidelines carefully before using our product. This product is not recommended for people under the age of 14. You hereby agree to this disclaimer and signify that you have read it thoroughly by using this product. You agree that you are responsible for your own conduct, any damage caused while using this product, and any consequence. You agree to only use this product for its designed purposes and under the local laws, regulations, and applicable policies and guidelines that HolyStone may provide.

2. When using this product, please strictly abide by the specification requirements and safety guidelines stated in this document. Any personal injury, property damage, legal disputes, and all other adverse events caused by violating any of the safety instructions or due to any other factor WILL NOT be HolyStone's responsibility.

2.0 SAFETY GUIDELINES

2.1 Check Before Use

- ① This product is a high-precision drone that integrates various electronic stability and control mechanisms. Please be sure to configure this drone carefully and correctly to ensure safe, accident-free operation.
- ② Ensure that the batteries of the drone and transmitter are clean, undamaged, and fully charged before every use.
- ③ Ensure that all the propellers are intact and are installed in the correct orientation.

④ Please perform a thorough check of the product before each use. Inspect the integrity of the parts, any signs of cracks and wear off on the propellers, battery power and effectiveness of the indicator, etc. If there is any problem found after checking the drone, please refrain from using it until the problem is resolved.

2.2 Flight Environment



+



+



Fly in Open Areas

Keep in Sight

**Fly Below
328 feet (100 m)**



Avoid flying over or near obstacles, crowds, high voltage power lines, trees, airports, or bodies of water.

DO NOT fly near strong electromagnetic sources such as power lines and base stations as it may affect the onboard compass.



DO NOT use this drone in adverse weather conditions like rain, snow, fog, and wind.

2.3 Operation Requirements

- ① DO NOT use this product to follow any moving vehicles.
- ② During the flight, turn off the motors only in an emergency.
- ③ When the battery runs low, return the drone back to your starting point.
- ④ DO NOT use this product if you feel tired, take medicine or feel unwell and drink alcohol.
- ⑤ Be aware of the volume of noise that the drone produces. Please ensure to keep your distance to avoid ear damage.



- ⑥ **Stay away from the rotating propellers and motors.**

- ⑦ **DO NOT fly in any spaces where drones are prohibited. Please respect people's right to privacy by not flying your drone close to others.**

2.4 Use of Battery

- ① Please ensure batteries are fitted in the correct orientation as shown in the instruction manual.
- ② Avoid short circuits by fitting the batteries correctly, and do not crush or squeeze the batteries as this could cause the risk of a fire or explosion.
- ③ DO NOT mix new and old batteries as this can lead to poor performance of the product.
- ④ Please dispose of used batteries carefully, do not litter, and recycle where ever possible.
- ⑤ DO NOT expose dead batteries to heat or fire, or they may explode.

- ⑥ If the device is not going to be used for an extended period of time, please remove batteries to prevent potential damage to the drone from battery leakage.
- ⑦ Only use the USB charging cable that comes with the drone to charge the battery.
- ⑧ DO NOT connect the battery directly to wall outlets or car cigarette-lighter sockets as this will damage your battery since they have different voltages.
- ⑨ DO NOT attempt to disassemble or modify the battery in any way.
- ⑩ DO NOT use the battery if it gives off an odor, generates heat, becomes discolored, deformed, or appears abnormal in any way. If any of these situations occur while the battery is in use or being charged, remove it from the device or charger immediately and discontinue use.
- ⑪ DO NOT pierce the battery casing with a nail or any other sharp object. Break it open with a hammer, or step on it! Dispose or recycle this battery as it may cause personal injury or damage to your drone.
- ⑫ Always charge the batteries on a fireproof surface and away from combustible materials. DO NOT charge on surfaces that can catch fire, including wood, cloth, carpet.
- ⑬ DO NOT immerse the battery in water or get it wet.
- ⑭ DO NOT solder battery terminal in any way.
- ⑮ Keep batteries out of reach of children or pets.
- ⑯ DO NOT short-circuit the battery by connecting wires or other metal objects to the positive(+) and negative(-) terminals.



Li-Po Battery Disposal & Recycling







Waste Lithium-polymer batteries must not be placed with household trash. Please contact local environmental or waste agency or the waste agency or the supplier of your model or your nearest Li-Po battery recycling center.



3.0 MAINTENANCE

- ① Clean the drone after each use with a clean, soft cloth.
- ② Avoid prolonged exposure to direct sunlight and avoid the buildup of heat on the drone or batteries.
- ③ This device is not waterproof and must not be submerged or subjected to water under any circumstance. Failure to keep the device completely dry will result in failure and permanent damage to the unit. Be aware that although it might be dry where you are, droplets of rain or mist from a river or waterfall could damage your drone where it is flying.
- ④ Frequently check the charging plug and other accessories for signs of damage. If any part of the device or cables is damaged, avoid use or charging until the damaged parts are replaced.

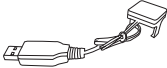
4.0 PACKAGE CONTENTS

 <p style="text-align: right;">× 1</p>	 <p style="text-align: right;">× 1</p>	 <p style="text-align: right;">× 1</p>
<p style="text-align: center;">Drone</p>	<p style="text-align: center;">Transmitter</p>	<p style="text-align: center;">Drone Battery</p>
 <p style="text-align: right;">× 2</p>	 <p style="text-align: right;">× 1</p>	 <p style="text-align: right;">× 1</p>
<p style="text-align: center;">Spare Propellers</p>	<p style="text-align: center;">USB Charging Cable</p>	<p style="text-align: center;">Screwdriver</p>
 <p style="text-align: right;">× 1</p>		
<p style="text-align: center;">Instructions For Use</p>		

5.0 DRONE DETAILS

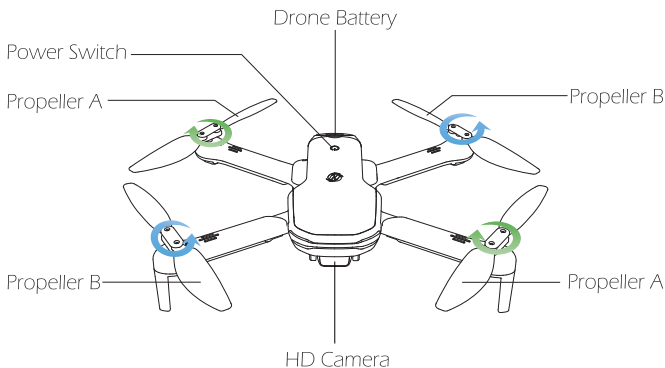

6.0 TRANSMITTER DETAILS

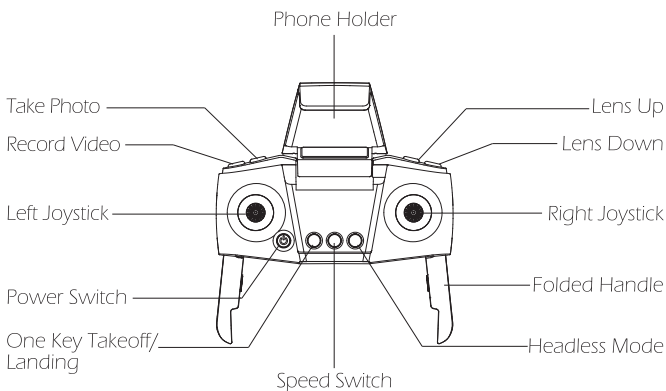

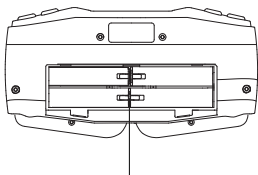

Battery Compartment



Battery Cover

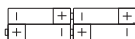

4×AAA Battery
(Not included)

Open the battery cover on the back of the transmitter, insert the four AAA batteries (**Not included**) into the battery compartment, and close the battery cover to complete the installation.



- When installing the batteries, please pay attention to the positive and negative polarity of the battery to ensure the correct installation of the batteries.
- Do not mix old and new batteries.
- When the batteries of the transmitter run low, the transmitter will start beeping, and its indicator light will blink red.

7.0 MODE SWITCH

7.1 MODE 2 (Left hand throttle MODE 2 will be the default setting.)

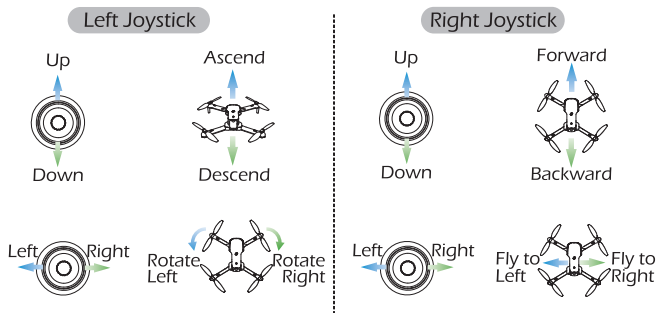

7.2 MODE 1

To enter MODE 1, turn on the transmitter while holding the “Record Video” button. (Please do not release the “Record Video” button until the transmitter is powered on.)

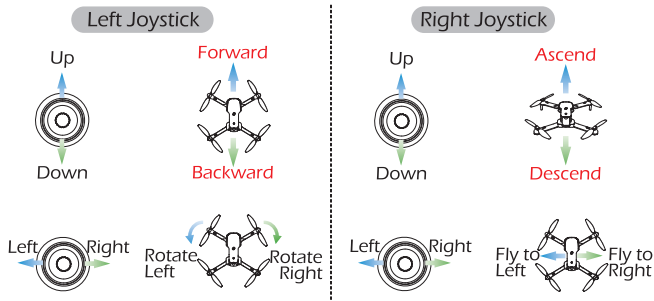

8.0 INSTALLATION

8.1 Propellers

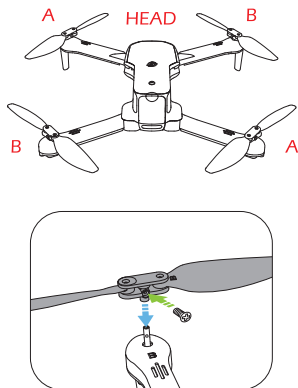

The propeller and the motor shaft marked with the same letter should be connected together (both are marked with the letter either A or B). Then install the propeller to the motor shaft with a screw.



- Install the propellers carefully to prevent accidental scratches.
- Please check that the propellers are properly installed and tightened before each flight.

8.2 Drone Battery

Installation:

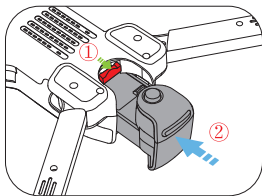

- ① Please remove the red insulation gasket first.
- ② Push the battery correctly into the drone battery compartment. Make sure that you hear a click sound, which indicates that the battery is firmly installed.

Attention:

The battery should be installed firmly. Otherwise, the flight safety of your drone may be affected. The drone may crash due to a power-cut during the flight.

Removal:

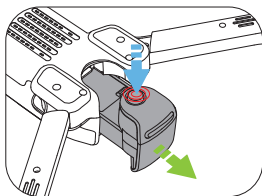

Press the lock button on the battery, and pull the battery out from the fuselage.

9.0 CHARGING

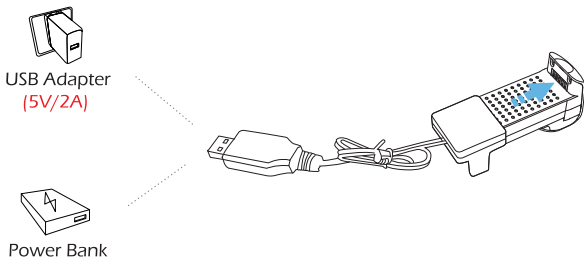

- 1) When the drone battery runs low, the indicator lights on the drone will flash continuously.
- 2) Remove the battery from the fuselage and connect the USB charging cable to the battery charging interface.
- 3) Plug the USB charging cable into a USB charging port on a power bank or a USB adapter (5V/2A).
- 4) The indicator light on the USB charging cable will turn on when the battery is charging, and will turn off when the battery is fully charged.
- 5) Charging time: About 70 minutes.



- Before charging, please read the instructions in the “Use of Battery” section of the “Safety Guidelines” carefully!
- DO NOT charge a battery immediately after a flight as the temperature may be too high. Please wait until it cools down to room temperature before charging again.

10.0 USING THE APP

10.1 Download App



iOS



Android APP on Google play

Scan the QR code, corresponding to either App Store™ or Google Play™ Store, and download the **HS FPV V4** app for free.

Required Operating Systems: **iOS 8.0** or later/**Android 5.0** or later

10.2 Connect to Wi-Fi

Connect your phone to the Wi-Fi network created by the drone. You can check the drone's status on the **HS FPV V4** App.

① Make sure to turn off Bluetooth, Mobile Data, and VPN. Enter your phone's Wi-Fi settings and click Wi-Fi to search for the Wi-Fi of the drone.

(Make sure to turn on the drone before going to the Wi-Fi settings on your phone)

② Select the Wi-Fi network: **HolyStone-*******.

③ Wait for a couple of seconds for your phone to connect to the drone's Wi-Fi.

④ Enter the **HS FPV V4** application.

> The connection between your phone and the drone is established automatically.

Attention: The Wi-Fi network created by the drone does not access the Internet.

11.0 OPERATION GUIDE

All of the operations shown in this manual are demonstrated using **MODE 2**.

11.1 Pairing

① Long press the power switch to turn on the drone and the indicator lights on the drone begin to flash.

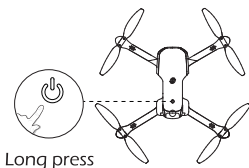

② Place the drone on a flat and level surface with the head forward and the tail facing towards the pilot.

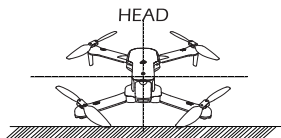

③ Short press the power switch on the transmitter to turn it on, and the indicator light on the transmitter will flash.

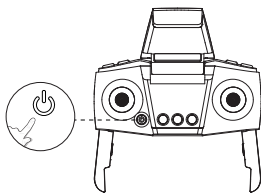

④ Push the left joystick up then down to pair the drone with the transmitter. The indicator lights on the drone and the transmitter will turn solid if the drone is paired successfully.

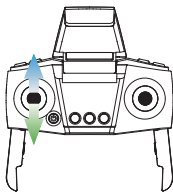

11.2 Calibrating the Gyro

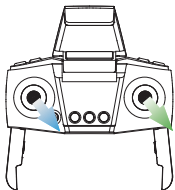

Simultaneously push the left joystick and the right joystick to the bottom right corner to calibrate the gyro. The indicator lights on the drone will blink, then turn solid, which indicates that the calibration is completed.

Tip: To ensure a stable flight, we suggest that the pilot calibrates the gyro every time after pairing the drone and after a crash.

11.3 Unlocking/Locking the Motors

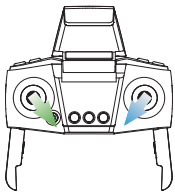

Unlocking: Simultaneously push the left joystick to the bottom right corner and the right joystick to the bottom left corner. The motors will rotate, and the drone is unlocked.

Locking: Repeat the operation, the motors will stop rotating immediately and the drone locks.

11.4 One Key Takeoff/Landing

Please unlock the motors before takeoff.

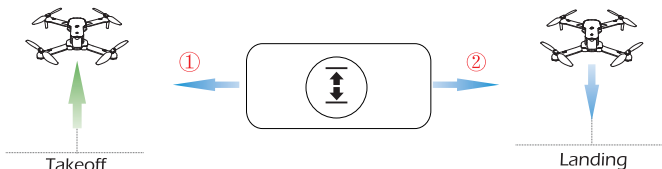

① Short press the One Key Takeoff/Landing button, the drone will take off automatically and hover at 5 feet. Now you can control this drone by using the joysticks.

② During the flight, short press the One Key Takeoff/Landing button, the drone will land on the ground automatically.

12.0 FUNCTION DETAILS

12.1 Emergency Stop

⚠ The Emergency Stop function should only be used in an emergency during the flight to avoid any damage or injury.

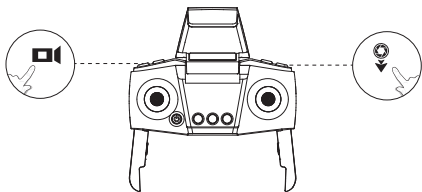

Press the Record Video and the Lens Down button simultaneously, and you will hear one beep from the transmitter. The drone will fall down immediately. Be aware that you risk breakage of the drone if it falls from a large distance or hits anything at a high rate of speed.

12.2 Speed Switch

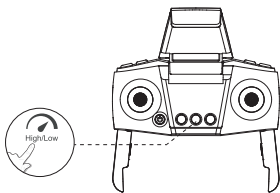

This drone comes with 2 speed modes (Low/High). Short press the Speed Switch button to switch the speed. A “Di” tone indicates Low speed and a “DiDi” tone indicates High speed.

(The Low speed is the default speed mode.)

12.3 Take Photo/Record Video

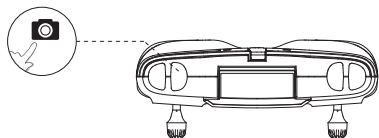

Take Photo: Short press the Photo button on the transmitter to take photos. You will hear one beep, which indicates that the camera has successfully taken one photo.

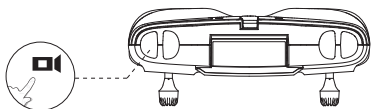



Record Video: Short press the Video button on the transmitter. You will hear two beeps which means the recording has started. Press again to exit the recording, and you will hear a long beep from the transmitter.

Attention: You can't take photos while recording videos.

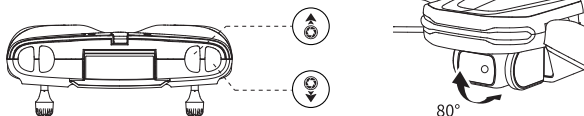
12.4 Camera Angle Adjustment



As shown above, you can adjust the camera to tilt up or down through the two buttons “” and “”.
(The camera has an 80° tilt range.)

12.5 Headless Mode

! Please familiarize yourself with the Headless Mode function first before using this mode. Otherwise, it is easy to lose the drone and cause unnecessary loss.

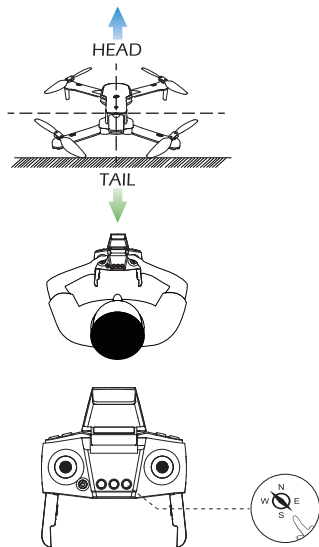

1. Short press the Headless Mode Button to enter the Headless Mode. In Headless Mode, the indicator lights of the drone will keep on flashing, and the transmitter will constantly beep.
2. Short press the Headless Mode Button again, and you will hear a long beep, the indicator lights on the drone will turn solid, which indicates that the drone has exited the Headless Mode.

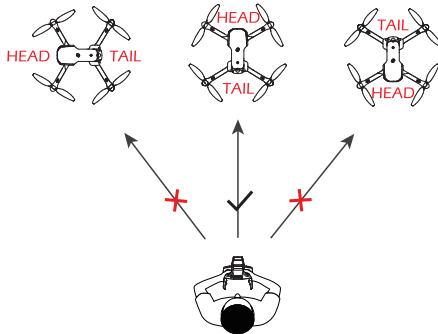

**Please make the pilot stays facing the same direction
that the drone head faces at takeoff.**

While in Headless Mode, pushing the right joystick forward will make it fly in the direction that the head of the drone faces when it takes off. To make sure the pilot can tell the drone's direction during the flight, we recommend that pilot stays facing the same direction that the drone head faces at takeoff. By doing so, it is ensured that when the pilot pushes the right joystick forward/backward, the drone will fly forward/backward toward the pilot. If the pilot pushes the right joystick left/right, the drone will move left/right relative to the pilot.

12.6 Trimmer

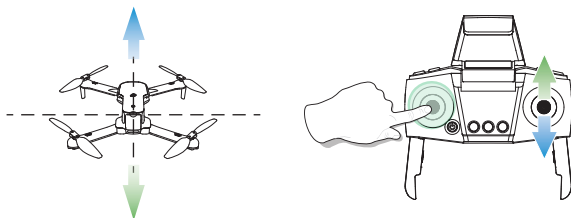

F/B Sideward Fly Trim: If the drone tends to drift forward, press down the left joystick and do not release it while pushing the right joystick down to balance the drone. If the drone tends to drift backward, press down the left joystick and do not release it while pushing the right joystick up to balance the drone.

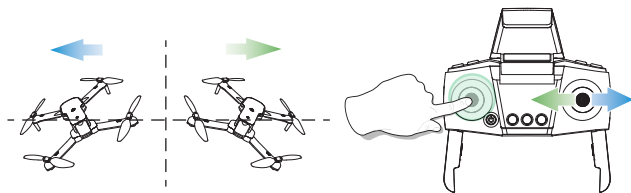

L/R Sideward Fly Trim: If the drone tends to drift left, press down the left joystick and do not release it while pushing the right joystick right to balance the drone. If the drone tends to drift right, press down the left joystick and do not release it while pushing the right joystick left to balance the drone.

12.7 Altitude-Hold Function

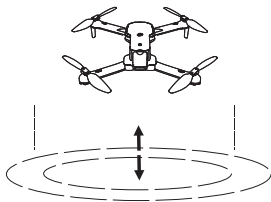

The drone is designed with an altitude-hold function to maintain its altitude after releasing the left joystick. (The left joystick will automatically spring back to the middle)

13.0 SPECIFICATIONS

DRONE

Model: HS280

Weight: 151g/5.33oz

Max Flight Time: 13minutes (per battery)

Operating Temperature Range: 32° to 104°F (0° to 40°C)

Size: 329 × 210 × 53 mm (Unfolded)

135 × 98 × 53 mm (Folded)

DRONE BATTERY

Capacity: 1300mAh

Voltage: 3.85V

Battery Type: Lithium-ion Polymer Battery

Energy: 5.01Wh

Charging Temperature Range: 41° to 104°F (5° to 40°C)

Charging Time: About 70 minutes

TRANSMITTER

Operating Frequency: 2.451-2.481GHz

Max Flight Distance: 328 feet/100 m (outdoor and unobstructed)

Battery Type: 4 × AAA Battery (not included)

Operating Temperature Range: 32° to 104°F (0° to 40°C)

CAMERA

Operating Frequency: 2.412-2.462GHz

Photo Resolution: 1920×1080P

Video Resolution: 1920×1080P@25fps

Max Transmission Distance: 328 feet/100m (outdoor and unobstructed)

Lens: FOV 65°

Controllable Range: -80° to 0°

Photo Formats: JPEG

Video Formats: AVI/MP4

Operating Temperature Range: 32° to 104°F (0° to 40°C)

USB CHARGING CABLE

Input: 5V/2A

Rated Power: ≤10 W

14.0 CONTACT US

Please do not hesitate to contact us if you need further support.

✉ usa@holystone.com (America)
ca@holystone.com (Canada)
eu@holystone.com (Europe)

☎ +1(855) 888-6699



For online support, please scan
this code with Live Chat

15.0 GENERAL INFORMATION

FCC Notice:

This device complies with Part 15 of the FCC Rules.

Operation is subject to the following two conditions:

- (1) This device may not cause harmful interference.
- (2) This device must accept any interference received, including interference that may cause undesired operation.

The Supplier's Declaration of Conformity is available at the following address:

https://www.holystone.com/Download/US/HS280_FCC_sDoC.pdf

NOTE: This equipment has been tested and found to comply with the limits for a Class B digital device, pursuant to Part 15 of the FCC Rules. These limits are set to provide reasonable protection against harmful interference in a residential installation. This equipment generates uses and can radiate radio frequency energy, if not installed and used in accordance with the instructions, it may cause harmful interference to radio communications. However, there is no guarantee that interference will not occur in a particular installation. If this equipment does cause harmful interference to radio or television reception, which can not be determined by turning the equipment off and on, the user is encouraged to try one or more of the following measures:

- Reorient or relocate the receiving antenna.
- Separation more distance between the equipment and receiver.
- Connect the equipment to an outlet on a circuit different from the receiver.
- Consult the dealer or an experienced radio/TV technician for help.

WARNING: Changes or modifications not expressly approved by the party responsible for compliance could void the user's authority to operate the equipment.

RF Exposure

The equipment complies with FCC radiation exposure limits set forth for an uncontrolled environment. This device should be installed and operated with a minimum distance of 20cm between the radiator & your body.

IC Notice:

This device complies with Canada Industry licence-exempt RSS standard(s). Operation is subject to the following two conditions:

- (1) this device may not cause interference; and
- (2) this device must accept any interference. Including interference that may cause undesired operation of the device.

CAN ICES-3 (B)

Avis d'Industrie Canada

Le présent appareil est conforme aux CNR d'industrie Canada applicables aux appareils radio exempts de licence. L'exploitation est autorisée aux deux conditions suivantes:

- 1) l'appareil ne doit pas produire de brouillage; et
 - 2) l'utilisateur de l'appareil doit accepter le brouillage radioélectrique subi même si le brouillage est susceptible d'en compromettre le fonctionnement.
- Le mauvais fonctionnement de l'appareil. Cet appareil numérique de la classe B est conforme à la norme NMB-003 du Canada.

CAN NMB-3 (B)

RF Exposure

Radiation Exposure Statement:

This equipment complies with IC radiation exposure limits set forth for an uncontrolled environment. This equipment should be installed and operated with a minimum distance of 20cm between the radiator & your body.

Déclaration d'exposition aux radiations:

Cet équipement est conforme aux limites d'exposition aux rayonnements IC établies pour un environnement non contrôlé. Cet équipement doit être installé et utilisé avec un minimum de 20 cm de distance entre la source de rayonnement et votre corps.

HOW TO RECYCLE THIS PRODUCT

This symbol on the product or its documentation indicates that it **MUST** not be disposed of together with household waste.

Uncontrolled waste disposal may harm the environment or human health. Please separate your device from other types of waste for recycling it responsibly.

This will help to foster the sustainable re-use of material resources.

We suggest you contact your retailer and inquire at your local town hall or business store to find out where and how the drone can be recycled.



BATTERY WARNING:

1. Failure to follow all the instructions may result in serious injury, and irreparable damage to the battery may cause a fire, smoke, or explosion as well.
2. Always check the battery's condition before charging or using it.
3. Please replace the battery if the battery is dropped or has any peculiar smell, overheating, discoloration, deformation, or leakage.
4. Never use anything other than the approved LiPo charger to charge the battery. Always use a balancing charger for LiPo cells or a LiPo cell balancer. It is recommended that you use the one provided with the product.
5. The battery temperature must never exceed 60°C(140°F); otherwise, the battery could be damaged or ignited.
6. Never charge the battery on a flammable surface, near flammable products, or inside a vehicle (preferably place the battery on a non-flammable and non-conductive surface).
7. Never leave the battery unattended during the charging process. Never disassemble or modify the housing's wiring, or puncture the cells. Always ensure that the charger output voltage corresponds to the voltage of the battery. DO NOT short circuit the batteries.
8. Never expose the Li-Po battery to moisture or direct sunlight, or store it in a place where temperatures could exceed 60°C(car in the sun, for example).
9. Always keep it out of reach of children.
10. Improper battery use may result in a fire, explosion, or other hazards.
11. Non-rechargeable batteries are not allowed to be recharged. Rechargeable batteries should be charged under adults' supervision.
12. DO NOT mix different types of batteries, including the new and used ones.

13. Batteries MUST be inserted with the correct polarity.
14. The supply terminals MUST not be short-circuited. Regular examination of transformer or battery charger for any damage to their cords, plugs, enclosures, and other parts MUST be done. If there is damage, they MUST not be used until the damage has been repaired.
15. The packaging has to be kept since it contains important information.
16. This toy should only be connected to the equipment with the symbol Class II. 

EU RF Power(EIRP): <10 dBm (2.451-2.481GHz)

Caution

1. The max operating of the EUT is 45°C and shouldn't be lower than -10°C.
2. The device complies with RF specifications when the device is used at 0mm from your body.
3. Declaration of Conformity.

We, Xiamen Huoshiquan Import & Export CO.,LTD hereby, declare that the compliance of the essential requirements with the Directive 2014/53/EU, the RoHS Directive 2011/65/EU and Safety Directive 2009/48/EC have been fully fulfilled on our product with indication below:

Product Name: Remote control four axis series

Model/Mark : HS280/HOLYSTONE

The Statement of compliance is available at the following address:

http://www.holystone.com/docs/HS280_EU_DOC.pdf

This product can be used among EU member states.

MANUFACTURER INFORMATION

Manufactured by

Xiamen Huoshiquan Import & Export CO.,LTD.

Address: Unit. 33, Room 806, NO. 2 Huming Road, Siming District, Xiamen, China

+1(855) 888-6699



Made in China