

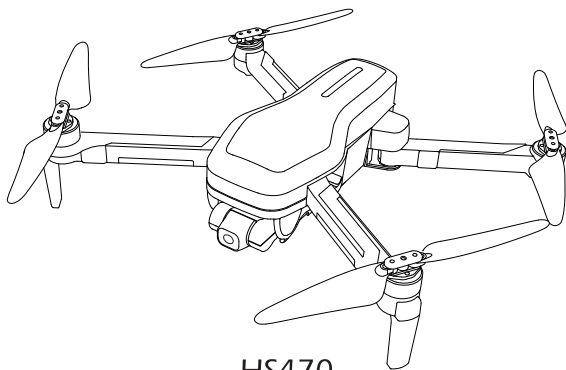



16+
age

Instructions For Use Gebrauchsanweisung

V1.0



HS470

 +1(855) 888-6699

 www.holystone.com

 usa@holystone.com (USA)
ca@holystone.com (CA)

eu@holystone.com (EU)

English

01-34

Deutsch

35-65

Contents

1.0 Disclaimer&Warning	01
2.0 Safety Guidelines	01
3.0 Maintenance	05
4.0 Package Contents	06
5.0 Drone's Details	07
6.0 Transmitter Details	
6.1 Transmitter Functions	08
6.2 LCD Screen Functions	10
7.0 Installation	
7.1 Drone Battery	11
7.2 Propellers	12
7.3 TF Card	13
7.4 Gimbal Cover	13
7.5 Control Sticks	14
7.6 Phone Holder.....	14
7.7 Antenna	15
8.0 Charging	16
9.0 Using The Application	
9.1 Download APP	17
9.2 Connect to Wi-Fi	17
10.0 Operation Guide	
10.1 Paring	18
10.2 Calibrating the Compass	19
10.3 GPS Searching	20
10.4 Calibrating the Gyro	21
10.5 Starting / Stopping the Motors	21

10.6 Takeoff / Landing	22
10.7 Flight Control	22
11.0 Functions Details	
11.1 Gimbal Dial	23
11.2 Headless Mode	24
11.3 Return to Home	25
12.0 Specifications	27
13.0 Contact Us	28
14.0 General Information	29

1.0 DISCLAIMER & WARNING

1. Please read this Disclaimer & Warning and Safety Guidelines carefully before using our product. This product is not recommended for people under the age of 16. By using this product, you hereby agree to this disclaimer and signify that you have read it fully. You agree that you are responsible for your own conduct and any damaged caused while using this product, and its consequences . You agree to use this product only for purposes that are proper and in accordance with local regulations, terms and all applicable polices and guidelines Holy Stone may make available.

2. When using this product, please be sure to strictly abide by the specification requirements and safety guidelines stated in this document. Any personal injury property damage, legal disputes and all other adverse events caused by the violation of the safety instructions or due to any other factor, WILL NOT be Holy Stone's responsibility.

2.0 SAFETY GUIDELINES

2.1 Check Before Use:

- ① This product is a high precision drone that integrates various electronic stability and control mechanisms. Please be sure to setup this drone carefully and correctly to ensure safe, accident-free operation.
- ② Please be sure that the batteries of the drone and transmitter are clean, undamaged and, fully charged.
- ③ Please be sure that all the propellers are undamaged and are installed in the correct orientation.

④ Please do a thorough check of the product before each use. Inspect the integrity of the parts, any signs of cracks and wear of the propeller, battery power and effectiveness of the indicator, etc. If after doing a complete check any issues are found, please refrain from using the product until the issue has been resolved.

2.2 Flight Environment:



+



+



Fly in Open Areas

**Maintain Line
of Sight**

**Fly Below
390 feet (120 m)**



Avoid flying over or near obstacles, crowds, high voltage power lines, trees, airport or bodies of water.

DO NOT fly near strong electromagnetic sources such as power lines and base stations as it may affect the onboard compass.



Don't use this drone in adverse weather conditions such as rain, snow, fog, and wind.

2.3 Operation Requirements :

- ① Please don't use this product to follow any moving vehicles .
- ② During the flight, only turn off the motor in case of an emergency.
- ③ As battery becomes low return the drone back to your starting point.
- ④ This product should not be used while drinking alcohol, if you are feeling fatigued, taking medicine, or feeling any physical discomfort.
- ⑤ Beware of the noise volume the drone produces. Keep your distance to avoid ear damage.





- ⑥ **Stay away from the rotating propellers and motors.**
- ⑦ **Don't fly in the No-Fly Zone.**

2.4 Use of Battery:

- ① Please ensure batteries are fitted in the correct orientation as shown in the instruction manual.
- ② Avoid short circuits by fitting the batteries correctly, and do not crush or squeeze the batteries as this could carry the risk of an explosion.
- ③ Do not mix new and old batteries as this can lead to a poor performance of the product.
- ④ Dispose used batteries carefully, do not litter.
- ⑤ Please keep dead batteries away from heat and fire.
- ⑥ If the device is not going to be used for an extended period of time, remove batteries to prevent potential damage from battery leakage.







- ⑦ It is recommended to only use the USB charging cable that comes with the drone to charge the battery.
- ⑧ Don't connect the battery directly to wall outlets or car cigarette-lighter sockets.
- ⑨ Don't attempt to disassemble or modify the battery in any way.
- ⑩ Don't use the battery if it gives off an odor, generates heat, becomes discolored or deformed, or appears abnormal in any way. If the battery is in use or being charged, remove it from the device or charger immediately and discontinue use.
- ⑪ Don't pierce the battery casing with a nail or other sharp object, break it open with a hammer, or step on it!
- ⑫ Always charge the batteries in a fireproof container and away from combustible materials. Don't charge on surfaces that can catch fire. This includes: wood, cloth, carpet, or in the application's device.
- ⑬ Don't immerse the battery in water or allow it to get wet.
- ⑭ Don't solder battery terminal directly.
- ⑮ Keep battery out of reach of children or pets.
- ⑯ Don't short-circuit the battery by connecting wires or other metal object to the positive(+) and negative(-) terminals.

	Li-Po Battery Disposal & Recycling	
<p>Waste Lithium-polymer batteries must not be placed with household trash. Please contact local environmental or waste agency or the waste agency or the supplier of your model or your nearest Li-Po battery recycling center.</p>		

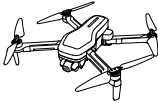
3.0 MAINTENANCE

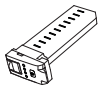
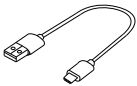
- ① Clean the product after each use with a clean, soft cloth.
- ② Avoid prolonged exposure to direct sunlight and avoid buildup of heat on the drone.
- ③ This device is not waterproof and must not be submerged in water under any circumstance. Failure to maintain the device completely dry will result in the failure of the unit.
- ④ Check the charging plug and other accessories for signs of damage frequently. If any part of the device is damaged, refrain from flying until maintenance can be carried out.

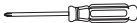
4.0 PACKAGE CONTENTS

 <p style="text-align: right;">× 1</p>	 <p style="text-align: right;">× 1</p>	 <p style="text-align: right;">× 1</p>
<p style="text-align: center;">Drone</p>	<p style="text-align: center;">Transmitter</p>	<p style="text-align: center;">Drone Battery</p>
 <p style="text-align: right;">× 1</p>	 <p style="text-align: right;">× 2</p>	 <p style="text-align: right;">× 4</p>
<p style="text-align: center;">USB Charging Cable</p>	<p style="text-align: center;">Control Sticks</p>	<p style="text-align: center;">Spare Propeller</p>
 <p style="text-align: right;">× 1</p>	 <p style="text-align: right;">× 1</p>	
<p style="text-align: center;">Screwdriver</p>	<p style="text-align: center;">Instructions For Use</p>	

5.0 DRONE'S DETAILS

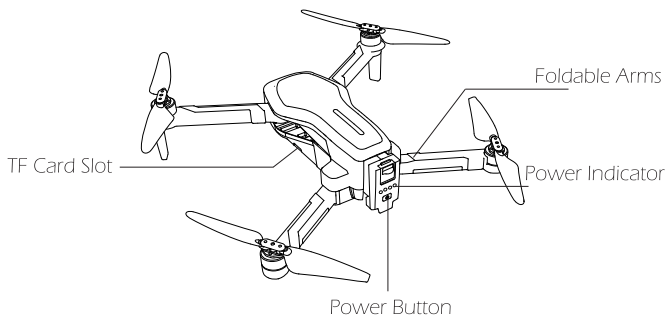
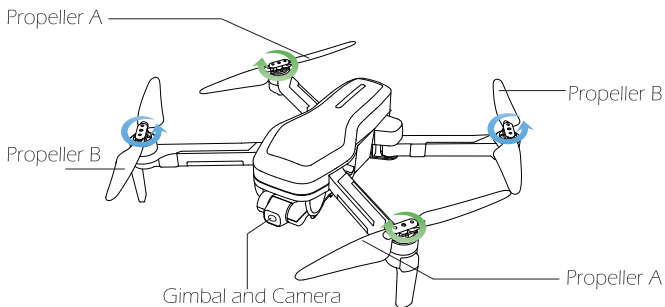

6.0 TRANSMITTER DETAILS

6.1 Transmitter Functions

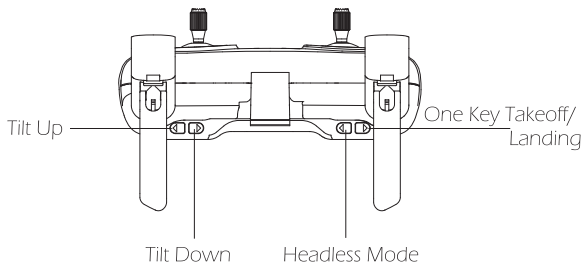
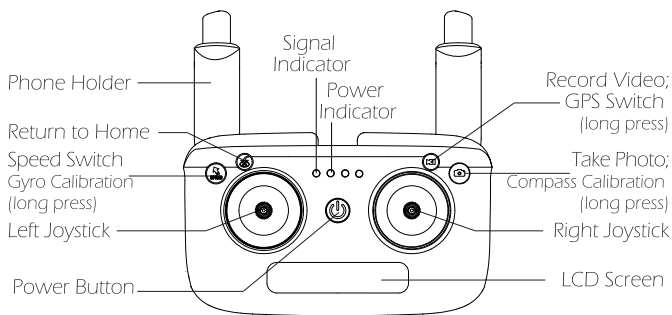

• Flight Mode Switch

The drone has two flight modes, Optical Flow Mode (Mode 1) and GPS Mode (Mode 2). The Flight Mode is locked in Mode 2 by default.



Mode 1: When flying indoors, you need to enter Mode 1 to operate the flight. After the compass and gyroscope are calibrated, turn off the GPS by pressing and holding the button () for about 5 seconds. At this time, the drone can be unlocked to take off.



Mode 2: Mode 2 works best when the GPS signal is strong. The drone utilizes the GPS and Optical Vision System to locate itself, automatically stabilize. When GPS signal search is completed, Mode 2 cannot be turned off.

• Return to Home (RTH)

Short press the button () to start the Return-to-Home (RTH) procedure. The drone will then return to the first recorded Take-off Point. Press this button again to cancel the RTH procedure and regain control of the drone.

• Photo/ Video

Short press the button () and the camera icon “” on the transmitter flashes once, the camera takes one photo.

Short press the button () and the video icon “” on the transmitter appears, indicating that the camera is taking video. Short press again will exit shooting and the video icon will disappear.

• Speed Switch

Press the button () once to switch speed. “Di” indicates Low Speed. “Di Di” indicates High Speed. (The Low Speed is default speed mode.)

6.2 LCD Screen Functions



Signal Strength



Satellites Connected



Satellites Connected



Altitude (Meter)



Distance(Meter)



One Key Return



Headless Mode



Video



Photo



Mode 1: Optical Flow Mode
Mode 2: GPS Mode (default)



Transmitter
Battery Level



Drone Battery Level

7.0 INSTALLATION

7.1 Drone Battery

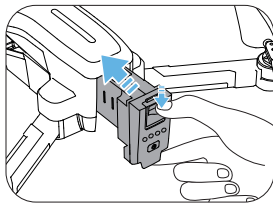

Installation: Press and hold the top and bottom tabs on the battery, and insert the battery into the battery compartment. The battery will firmly click in when it is properly installed.

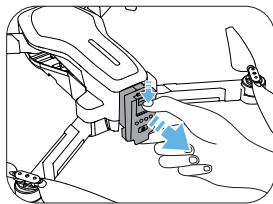

Removal: Press and hold the top and bottom tabs on the battery, and pull it out slowly.

Attention:

- Make sure the battery is powered off before installation or removal.

7.2 Propellers

Installation

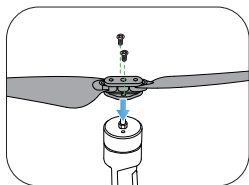
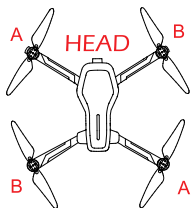

The drone will not fly unless the correct propeller is installed on the correct motor shaft. See illustration above. An "A" or "B" is printed on the back of each propeller. Lock the propeller to the motor shafts with screws rotating each screw clockwise.

Removal

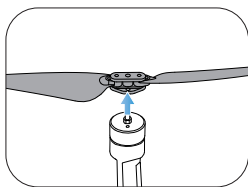
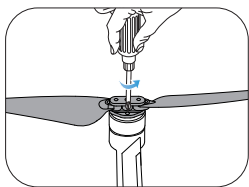

For propeller removal use screwdriver (provided) to rotate counter-clockwise and remove propellers.

7.3 TF Card

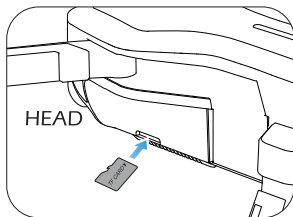

To store your photos and videos, insert the TF card (not included) into the slot as shown above before turning on the drone. The drone supports TF card up to 128 GB.

7.4 Gimbal Cover

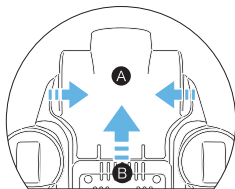

Remove the gimbal cover from the camera.

Tips:

- The gimbal cover is used to protect the gimbal. Remove it when necessary.
- Attach the gimbal cover when not in use.

7.5 Control Sticks

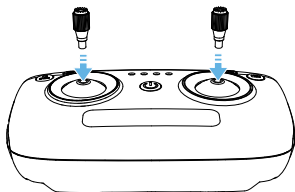

Install the two control sticks into the grooves on the transmitter and press them into place.

7.6 Phone Holder

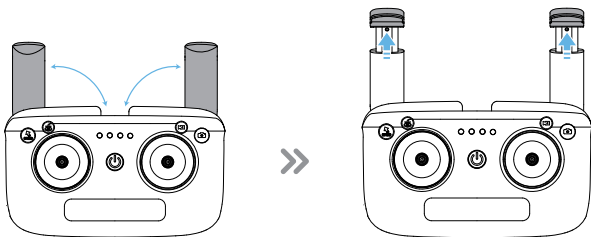

Expand the phone holder and place your mobile phone adjust the clamp to secure.

7.7 Antenna

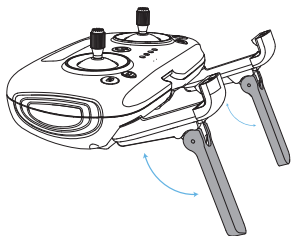

Before starting the flight, you can expand the two antennas on the transmitter separately.

8.0 CHARGING

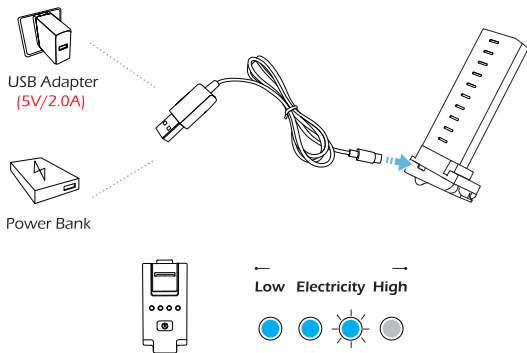

- ① Please charge the battery in the closed state. Connect the Battery to the USB Charging Cable.
- ② Connect the USB Charging Cable with Power Bank or a USB Adapter (5V / 2.0A) for charging.
- ③ When the battery is charging, the indicator lights on the battery will flash blue.
- ④ When the battery is full charged, all four blue indicators on the battery will turn solid.
- ⑤ The charging time is about 6~8 hours.



- Before charging, please check the contents of the " **Use of Battery**" section of the " **Safety Guidelines**" carefully!
- Always turn off the battery before inserting it or removing it from the drone. Never insert or remove a battery when it is turned on.

9.0 USING THE APPLICATION

9.1 Download APP



iOS



Android APP on Google play

Scan the QR code, corresponding to either App Store™ or Google Play™ Store and download the **HFun Pro** app for free.

9.2 Connect to Wi-Fi



Turn on the drone, and then connect your smart phone to the Wi-Fi network created by the drone. Check the drone's status in the **HFun Pro** app.

- ① Your smartphone will launch a search of the available Wi-Fi networks:
- ② Select the Wi-Fi network: **XL-PRO-4K-5G-*****.
- ③ Wait for several seconds until your smartphone connect to the Wi-Fi network of the drone.

This connection is generally represented by the Wi-Fi logo appearing on your smartphone's screen.

- ④ Launch the **HFun Pro** application.

> The connection between your smartphone and the drone will be established automatically.

10.0 OPERATION GUIDE

10.1 Pairing

① Press and hold the Power Button for 3 seconds to turn on the drone.

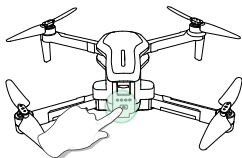

② Place the drone on a flat and level surface with the head forward and the tail towards the pilot.

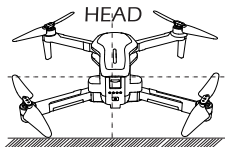

③ Press the Power Button to turn on the transmitter. Once the transmitter sends out two beeps, it means that the drone has been successfully paired with the transmitter.

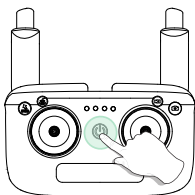

10.2 Calibrating the Compass

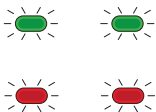
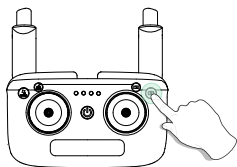

Step 1: Press and hold the Photo button for 3 seconds to enter the compass calibration. The all indicator lights of the drone will flash quickly.

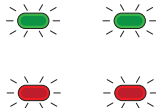
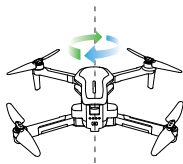

Step 2: Hold the drone horizontally and rotate the drone in 3 complete circles. When completed the transmitter will make a beep.

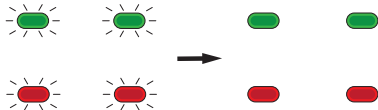
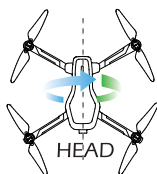

Step 3: Hold the drone vertically and rotate the drone in 3 complete circles. When completed the front green lights and rear red lights will turn solid and the transmitter will make a beep.

10.3 GPS Searching

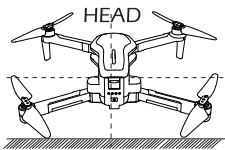

After the compass calibration is completed, place the drone on a flat and level surface, and the drone will start searching for GPS signals. When the GPS satellite number icon on the transmitter displays number 10, it means that the GPS signal search is complete.

ATTENTION:

- DO NOT calibrate your compass where there is a chance of strong magnetic interference, such as magnetite, parking structures, and steel reinforcements underground.
- When flying indoors, please hold the Video button for about 5 seconds to exit GPS Mode. You can fly this drone when you complete the Compass Calibration operations if you exit GPS mode. The drone is in Optical Flow Mode at this time.

10.4 Calibrating the Gyro

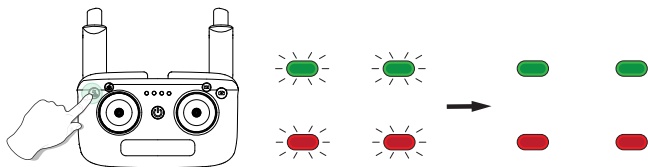

Press and hold the Speed Switch button for 3 seconds to calibrating the gyro. When the drone's front green indicator lights and rear red indicator lights change from quick flash to solid, which means the gyroscope calibration is completed.

· To ensure a stable flight, we recommend that pilots perform a compass calibration before each flight.

10.5 Starting / Stopping the Motors

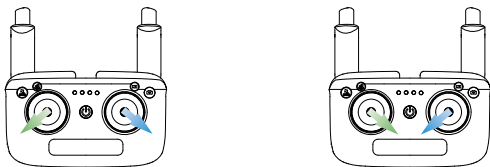

· **Starting the Motors:** As shown above, push both joysticks to the bottom outer corners or the bottom inner corners to start the motors. Once the motors have started spinning, release both joysticks simultaneously.

· **Stopping the Motors:** Repeat the same operation, motors will stop immediately. Release both joysticks once motors stop.

10.6 Takeoff / Landing

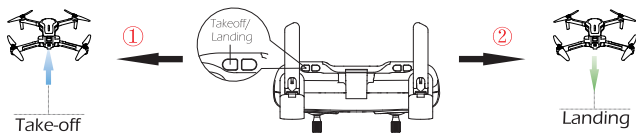

- ① After starting the motor, press the One Key Takeoff/ Landing button, the drone will automatically take off and hover at 5 feet altitude.
- ② When the drone is flying, press the One Key Takeoff/ Landing button again, the drone will automatically land on the ground.

10.7 Flight Control

Control the flight by using joysticks.

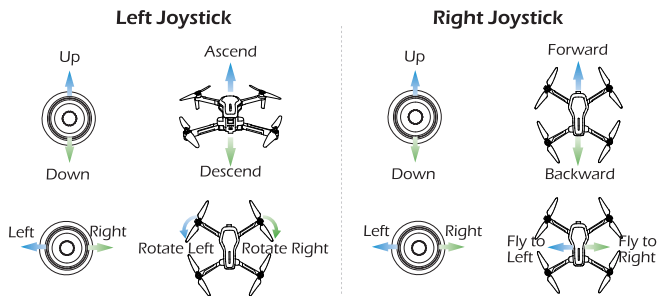

11.0 FUNCTION DETAILS

11.1 Gimbal Dial

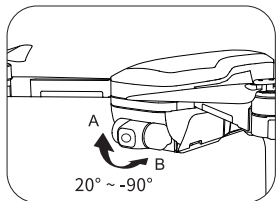
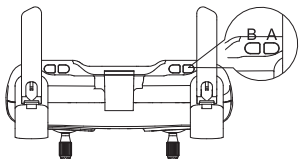

The gimbal provides a steady platform for the attached camera, allowing you to capture clear, stable images and video. The gimbal can tilt the camera within a 20° to -90° range.

Use the gimbal dial button on the transmitter to control the tilt movement of the camera.

11.2 Headless Mode

Short press the Headless Mode button until the “” icon appears on the LCD screen, which means the drone has entered Headless Mode.

Short press the Headless Mode button again until the “” icon on the LCD screen disappears meaning that the drone has exited Headless Mode.

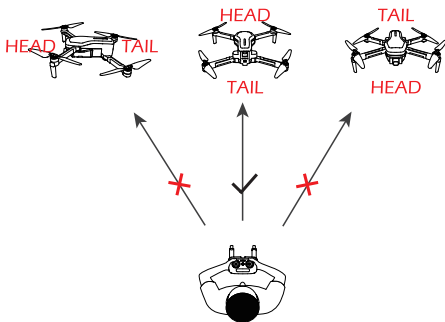

Please make the pilot stays facing the same direction as the direction that the head of the drone faces at take-off.

While in Headless Mode, pushing forward on the joystick will make it fly in the direction that the head of the drone faces at take-off.

To make sure that the pilot can tell drone's direction, we recommend that pilots stay facing the same direction that the drone head faces at take off.

By doing so it is ensured that when the pilot pushes the direction joystick forward/ backward, the drone will fly forward/ backward toward him/ her. If the pilot move the right stick left/ right, the drone will move left/ right relative to the pilot.

11.3 Return to Home (RTH)

- The Return to Home function brings the drone back to the last recorded Take-off Point.
 - The Take-off Point is the location where GPS first receives signals from 7 or more satellites before take-off. The current position of the drone will be recorded as the Take-off Point.
-

11.3.1 Smart RTH

The Return to Home function only works in GPS mode. To manually activate the Return to Home function, you can press the Return to Home button “” on the transmitter.

When the Return to Home command has been successfully received, the drone automatically maneuvers itself to return directly and land at the preset Take-off Point. Make sure there are no buildings or other obstacles in the flight path.

You can also press the same button again to exit the RTH function. Then push down on the throttle joystick to land the drone in a safe area.

11.3.2 Failsafe RTH

If the GPS signal is available (at least 7 satellites) and the Take-off Point is recorded previously. Failsafe Return will be triggered if the transmitter signal is lost for more than 6 seconds. The drone will automatically start the return procedure and it will fly back to the last recorded Take-off Point.

If the signal recovers during the return, the drone will stop returning and hover in the air.

11.3.3 Low Voltage RTH

1) When the drone's rear lights flash slowly, the “” symbol is displayed on the screen of the transmitter, the First Low Voltage RTH will be triggered. The drone will automatically enter the return-to-home procedure, and then the drone can only fly within a safe range of the height no more than 65 ft (20 m) and the distance no more than 65 ft (20 m).

2) When the drone's rear lights flash slowly, the “” symbol is displayed on the screen of the transmitter, the Second Low Voltage RTH will be triggered.

- ① If drone's current altitude is greater than 65 ft, the drone will return to the home point at the current altitude.
- ② If drone's current altitude is lower than 65 ft, the drone will first automatically ascend to 65 ft, from the current altitude.



- During the return procedure, the drone can NOT avoid obstacles.
- Make sure there are no buildings or other obstacles in the flight path.
- The drone cannot Return-to-Home if the GPS signal is weak (satellites number is less than 7).

12.0 SPECIFICATIONS

DRONE

Model: HS470

Weight: 543g / 19 oz

Max Flight Time: 21 minutes (per battery)

Operating Temperature Range: 32° to 104°F

Size: 180 x 95 x 80 mm (Folded)

365 x 365 x 70 mm (Unfolded)

DRONE BATTERY

Capacity: 2800 mAh

Voltage: 7.4 V

Battery Type: Li-Po

Energy: 20.72 Wh

Charging Temperature Range: 41° to 104°F (5° to 40°C)

Charging Time: about 6~8 hours

TRANSMITTER

Operating Frequency: 2.4 GHz

Transmitter Power (EIRP): <16 dBm

Max Flight Distance: 3280 feet / 1000m (outdoor and unobstructed)

Battery Type: 4× 1.5V AA batteries (Not included)

Operating Temperature Range: 32° to 104°F

USB CHARGING CABLE

Voltage: 5 V $\overline{\text{---}}$ 2A

Rated Power: \leq 10 W

13.0 CONTACT US

Please do not hesitate to contact us if you need further support.

 usa@holystone.com (America)
ca@holystone.com (Canada)
eu@holystone.com (Europe)

 +1(855) 888-6699

14.0 GENERAL INFORMATION

FCC Statement:

Any Changes or modifications not expressly approved by the party responsible for compliance could void the user's authority to operate the equipment.

This device complies with part 15 of the FCC Rules. Operation is subject to the following two conditions:

- (1) This device may not cause harmful interference, and
- (2) This device must accept any interference received, including interference that may cause undesired operation.

NOTE: This equipment has been tested and found to comply with the limits for a Class B digital device, pursuant to Part 15 of the FCC Rules. These limits are designed to provide reasonable protection against harmful interference in a residential installation. This equipment generates uses and can radiate radio frequency energy and, if not installed and used in accordance with the instructions, may cause harmful interference to radio communications. However, there is no guarantee that interference will not occur in a particular installation. If this equipment does cause harmful interference to radio or television reception, which can be determined by turning the equipment off and on, the user is encouraged to try to correct the interference by one or more of the following measures:

- Reorient or relocate the receiving antenna.
- Increase the separation between the equipment and receiver.
- Connect the equipment into an outlet on a circuit different from that to which the receiver is connected.
- Consult the dealer or an experienced radio/TV technician for help.

WARNING: Changes or modifications not expressly approved by the party responsible for compliance could void the user's authority to operate the equipment.

RF Exposure

The equipment complies with FCC radiation exposure limits set forth for an uncontrolled environment. This device should be installed and operated with minimum distance 20cm between the radiator & your body. This part belongs to the drone.

RF warning for Portable device: The device has been evaluated to meet general RF exposure requirement. The device can be used in portable exposure condition without restriction. This part belongs to the transmitter.

IC Notice:

This device complies with Canada Industry licence-exempt RSS standard(s).

Operation is subject to the following two conditions:

- (1) this device may not cause interference; and
- (2) this device must accept any interference. Including interference that may cause undesired operation of the device.

CAN ICES-3 (B)

Avis d'Industrie Canada

Le présent appareil est conforme aux CNR d'industrie Canada applicables aux appareils radio exempts de licence L'exploitation est autorisée aux deux conditions suivantes:

- 1) l'appareil ne doit pas produire de brouillage; et

2) l'utilisateur de l'appareil doit accepter brouillage radioélectrique subi même si le brouillage est susceptible d'en compromettre le fonctionnement. mauvais fonctionnement de l'appareil. Cet appareil numérique de la classe B est conforme à la norme NMB-003 du Canada.

CAN NMB-3 (B)

RF Exposure

Radiation Exposure Statement:

This equipment complies with IC radiation exposure limits set forth for an uncontrolled environment. This equipment should be installed and operated with minimum distance 20cm between the radiator & your body.

Déclaration d'exposition aux radiations:

Cet équipement est conforme aux limites d'exposition aux rayonnements IC établies pour un environnement non contrôlé. Cet équipement doit être installé et utilisé avec un minimum de 20 cm de distance entre la source de rayonnement et votre corps.

HOW TO RECYCLE THIS PRODUCT

This symbol on the product or its documentation indicates that it must not be disposed of with household waste.

Uncontrolled waste disposal may harm the environment or human health. Please separate your device from other types of waste to recycle it responsibly.

This will help to foster the sustainable re-use of material resources.

We invite you to contact your retailer or inquire at your local town hall to find out where and how the drone can be recycled.

BATTERY WARNING:

1. Failure to follow all the instructions may result in serious injury, irreparable damage to the battery and may cause a fire, smoke or explosion.
2. Always check the battery's condition before charging or using it.
3. Replace the battery if it has been dropped, or in case of odor, overheating, discolouration, deformation or leakage.
4. Never use anything other than the approval LiPo charger the battery. Always use a balancing charger for LiPo cells or a LiPo cell balancer. It is recommended that you do not to use any other charger than the one provided with the product.
5. The battery temperature must never exceed 60°C (140°F) otherwise the battery could be damaged or ignite.
6. Never charge battery on a flammable surface, near flammable products or inside a vehicle (preferably place the battery in a non-flammable and nonconductive container).
7. Never leave the battery unattended during the charging process. Never disassemble or modify the housing's wiring, or puncture the cells. Always ensure that the charger output voltage corresponds to the voltage of the battery. Do not short circuit the batteries.
8. Never expose the LiPo battery to moisture or direct sunlight, or store it in a place where temperatures could exceed 60°C (car in the sun, for example).
9. Always keep it out of reach of children.
10. Improper battery use may result in a fire, explosion or other hazard.



11. Non-rechargeable batteries are not to be recharged. Rechargeable batteries are only to be charged under adult supervision.
12. Different types of batteries or new and used batteries are not to be mixed.
13. Batteries are to be inserted with the correct polarity.
14. The supply terminals are not to be short-circuited. Regular examination of transformer or battery charger for any damage to their cord, plug, enclosure and other parts and they must not be used until the damage has been repaired.
15. The packaging has to be kept since it contains important information.
16. The toy is only to be connected to Class II equipment bearing the symbol. 

Caution

1. The max operating of the EUT is 45°C. and shouldn't be lower than -10°C.
2. The device complies with RF specifications when the device used at 0mm from your body.
3. Declaration of Conformity.

We, Xiamen Huoshiquan Import & Export CO.,LTD hereby, declare that the essential requirements compliance with the Directive 2014/53/EU, the RoHS Directive 2011/65/EU and Safety Directive 2009/48/EC have been fully fulfilled on our product with indication below:

Product Name: REMOTE CONTROL MODEL/RADIO CONTROLLED
Model/Mark : HS470/HOLYSTONE

The Statement of compliance is available at the following address:

http://www.holystone.com/Download/CE/HS470_EU_DOC.pdf

This product can be used across EU member states.

MANUFACTURER INFORMATION

Manufactured by

Xiamen Huoshiquan Import & Export CO.,LTD

Room 703,No. 813-2 Xiahe Road, Siming District, XIAMEN, China

+1(855) 888-6699



FAA REGISTRATION: PLEASE FOLLOW ALL FEDERAL, STATE AND LOCAL FAA LAWS. YOU MAY BE REQUIRED TO REGISTER YOURSELF AND YOUR DRONE WITH THE FAA MORE INFO CAN BE FOUND AT: [HTTPS://WWW.FAA.GOV/UAS/GETTING STARTED/](https://www.faa.gov/uas/getting-started/)

After receiving the certificate of registration, you must mark your **unique FAA registration number** on the Drone by any means, such as permanent marker, label, engraving. This number must be readily accessible and maintained in a condition that is readable and legible upon close visual inspection

WARNING: Do **NOT** fly drone near airports or any other un-authorized areas. Follow all rules for Federal Aviation Administration (FAA) regulation summary for Small Unmanned Aircraft Systems (sUAS).

Read: Academy of Model Aeronautics (AMA) Know Before You Fly important information brochure.



Made in China

