

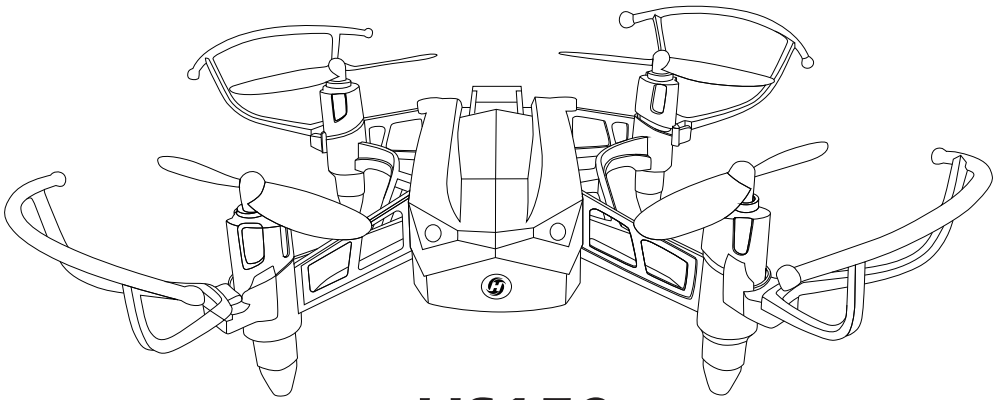

14⁺
age

INSTRUCTIONS FOR USE



HS150



usa@holystone.com (America)

ca@holystone.com (Canada)

eu@holystone.com (Europe)

jp@holystone.com (Japan)



+1(855) 888-6699

www.holystone.com

Contents

1. Preface	1
2. Warnings	2
3. Maintenance	3
4. Package Contents	4
5. Specification	5
6. Drone's Details	6
7. Transmitter Functions	6
8. Charging the Drone Battery	7
9. Assemble the Drone	9
10. Safe Fly Information	10
11. Flight	11
- Pairing the Drone	11
- Calibrate the Gyro	12
- Flight Control	13
12. Low Battery Warning	15
13. Flip Mode	15
14. Headless Mode	16
15. Trouble Shooting.....	18
16. General Information	19

To make your experience with this drone as straightforward and convenient as possible, please read this Instructions For Use before operating and keep it for the future reference and maintenance.

Important Statement:

1. This product is not a toy, but it is a high precision drone that integrates various electronic stability and control mechanisms. This drone requires careful and correct assembly and setup to ensure safe, accident-free operation. This equipment should be operated in a safe and controlled manner at all times. Incorrect or hazardous operation may cause damage to the device or property, or cause serious injury to those in the vicinity.
2. This product is suitable for experienced drone pilots over 14 years of age.
3. In case of having difficulties on any aspect of the product, operation or maintenance, please contact your local sales agent or contact customer support here at Holy Stone.

Safety Guidelines

This product is Mini RC Drone that offers easy, controllable flight when in good working order, however, there is also a significant risk to property and people if flown irresponsibly or within confined spaces. Incorrect assembly or poor control by inexperienced pilots can result in damage to property or harm to people in an accident. Be fully aware of your surroundings when flying and always maintain complete control of the vehicle at all times.

1. Keep in Distance:

- a. Always fly in locations that are clear of any obstructions, such as buildings, poles, electrical wires, trees and so on.
- b. Never fly above or near people and spectators.

2. Do not fly in adverse weather conditions:

- a. Keep clear of moisture, fog, ice and excessive wind.
- b. Fly in good weather conditions only.

3. Use and maintain the product according to the instructions for use:

- a. Operate this device legally in accordance with instructions provided and with local laws and regulations.
- b. Always use original parts manufactured by Holy Stone for maintenance and repair.

4. Do not operate the device alone.

- a. If you are a new pilot, seek assistance from an experienced drone pilot when learning.
- b. Have others around to help you fly at all times.

5. Safety First every time:

- a. Always operate the drone within your ability as a pilot. If you are ill, disoriented, or unsure of how to effectively fly the drone, please seek help to avoid danger, damage or injury.

6. Keep clear of rotation parts:

- a. During operation the rotors revolve extremely quickly, please avoid touching the blades and ensure that foreign objects are kept clear of all moving parts.

7. Avoid exposure to excessive heat:

a. Due to the numerous material types used in construction, this drone is not suitable for exposure to heat. Please keep your device away from heat sources and avoid prolonged exposure to direct sunlight. High temperatures are capable of distorting the structure of drone and lead to unpredictable consequences.

<WARNINGS>









1. The information and guidance within this package and instructions for use are important for the safe operation and maintenance of your drone. Please keep it well for future reference.
2. You accept sole responsibility for any injury, loss or damage that result from your operation of the device.
3. Always follow the instructions when assembling or operating the drone. Always keep at least 2 meters between the user or viewers and the model to avoid risk of injury. Pay attention to the device at all times while flying.
4. Neither Holy Stone nor any distributors or agents accepts any responsibility for loss, injury or damage caused by incorrect operation of the drone.
5. This drone is not suitable for children under the age of 14. Younger pilots should always operate the drone under the supervision of an adult.
6. Please ensure assembly instructions are followed correctly to ensure proper operation and performance of your drone.
7. This product contains small parts. To avoid any choking hazard, please keep this drone and all its components out of the reach of children.
8. To avoid accidents, under no circumstances should this drone be flown over open water or near public roads.
9. Keep all packaging materials away from children and dispose them in a safe manner.
10. The internals of the drone are not user serviceable. To avoid malfunctions during flight, please do not attempt to disassemble this drone or replace any part of the drone.
11. Please ensure batteries are fitted in the correct orientation as shown in this instructions.
12. You can access the transmitter battery compartment by unscrewing the screws on the battery cover. inserting batteries to ensure they are in the right orientation. Always put battery cover back and tighten the screw to secure before use.
13. Only use the charger provided with your drone for safety.
14. The charger is not a toy.
15. Always pay close attention to battery polarity when inserting any batteries to make sure they are fitted correctly.
16. Use either rechargeable or nonrechargeable "AA" batteries in the transmitter. Do not mix battery types.
17. Use only recommended batteries in the transmitter, please remember that non-rechargeable batteries must not be charged.

18. For rechargeable batteries, always follow manual instructions for use and have adult supervision. Do not leave charging batteries unsupervised and as batteries get hot when charging, avoid any combustible material.
19. Avoid short circuits by fitting the batteries incorrectly, and do not crush or squash batteries as this carries a risk of explosion.
20. Do not mix new and old batteries as this can lead to unpredictable performance.
21. Dispose used batteries carefully, and do not litter.
22. The power socket must not be removed from this drone. Do not attempt to short-circuit the connection socket.
23. When disposing batteries, do not throw on fires, leave to decompose. Keep clear of heat sources and high temperatures at all time.
24. If the device is not going to be used for an extended period, remove batteries to prevent potential damage from battery leakage.
25. Care should be taken to keep your drone away from sources of magnetic interference of otherelectrical equipment to prevent signal issues during operation.
26. Keep clear of rotating parts and beware of loose clothing that could become entangled in the rotors causing injury.
27. Beware of the noise volume the drone produces. Keep your distance to avoid hearing impairment.
28. The charger socket uses a mini USB 5V connection.
29. Always use the product in compliance with local aviation radio rules and comply with local authorities who require you to refrain from operating at any time.

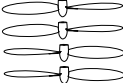
<MAINTENANCE>

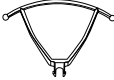
1. Clear the product after each use with a clean, soft cloth.
2. Avoid prolonged exposure to direct sunlight and avoid buildup of heat on the drone.
3. This device is not waterproof and must not be submerged in water under any circumstance. Failure to maintain the device completely dry will result in the failure of the unit.
4. Check the charging plug and other accessories for signs of damage frequently. If any part of the device is damaged, refrain from flying until maintenance can be carried out.

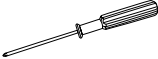
Package Contents

No.	Part Name	Picture	Quantity
1	Drone		1
2	Transmitter		1
3	3.7V 600mAh Li-Po Battery		2
4	Additional Propeller		8
5	USB Charging Cable		1
6	Propeller Guard		4
7	Propeller Spanner		1
8	Screwdriver		1
9	Landing Cushion		2
10	Instructions For Use		1

DRONE

Model: HS150

Weight: 48.5g

Flight Time: 5~7 minutes

Motor Model: 8620

Operating Temperature Range: 32° to 104°F (0° to 40°C)

Dimensions: 150 x 150 x 50mm

Transmitter

Operating Frequency: 2.4GHz

Max transmission distance: 80m

(Outdoor And Unobstructed)

Battery: 1.5V Alkaline Battery

Operating Temperature: 32° to 104° F (0° to 40° C)

FLIGHT BATTERY

Capacity: 600 mAh

Voltage: 3.7 V

Battery Type: LiPo

Energy: 2.22Wh

Net Weight: 19.0g

Charging Temperature Range: 41° to 104°F (5° to 40°C)

Charging Time: 90 mins **(Depending on Charging Power)**

<DRONE'S DETAILS>

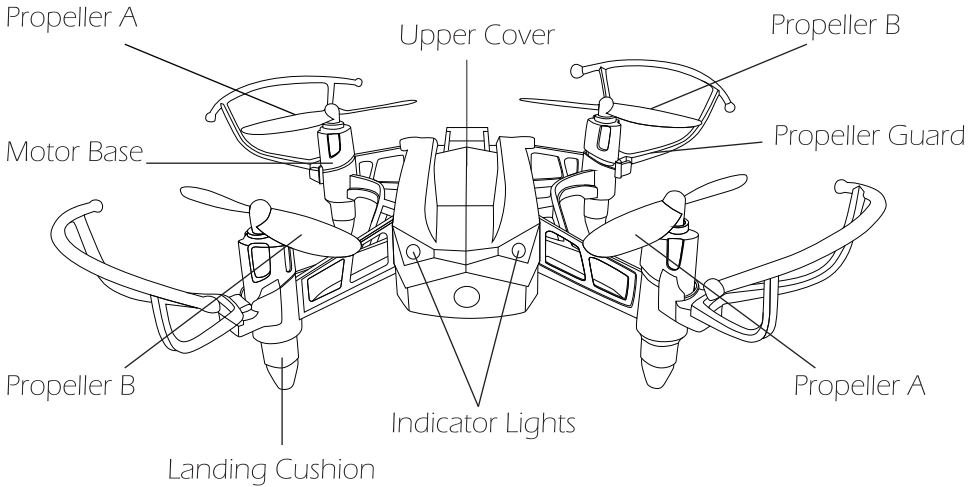

! It is crucial that all propellers are installed in the correct orientation (Pay attention to the letter "A" or "B" printed underneath each propeller.)

< TRANSMITTER FUNCTIONS >

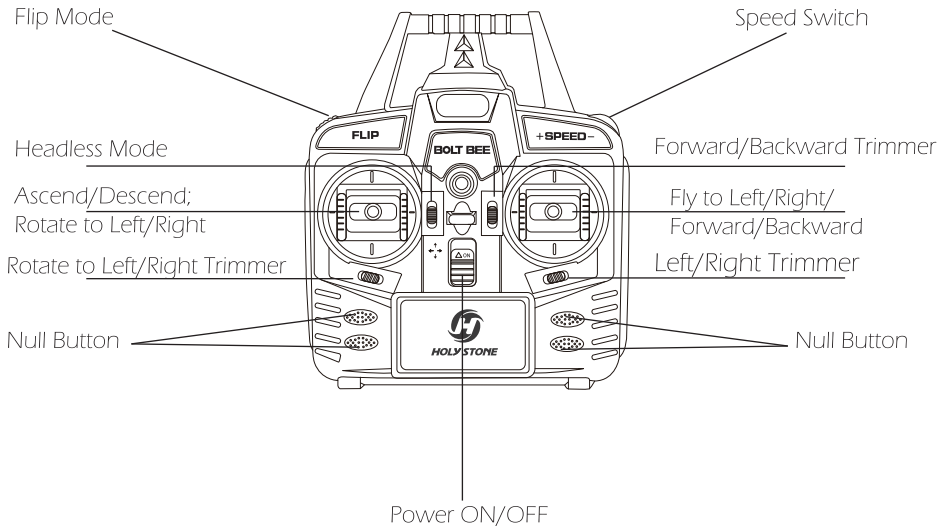

< TRANSMITTER BATTERIES INSTALLATION >

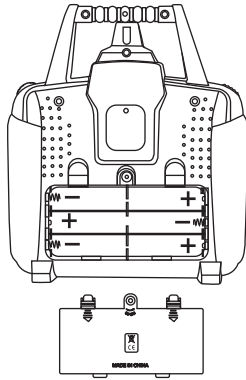

Battery Cover

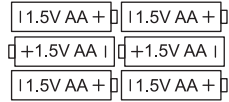

6 AA Batteries
(Not Included)

< CHARGING THE DRONE BATTERY >

1. Remove the battery from the drone as shown on the diagram below.
2. Connect the battery to the USB charging cable (Included in the box).
3. Insert the USB charging cable into USB port or a wall adapter (5V/0.5~1A).
The red indicator light will turn on when the battery starts charging, and will turn off when the battery is fully charged.
4. It takes around 90 minutes to fully charge the battery.
5. The flight time is about 5~7 minutes on each fully-charged battery.

Note:

If you use an adapter to charge the battery, please use a 5V adapter to connect the USB charging cable.

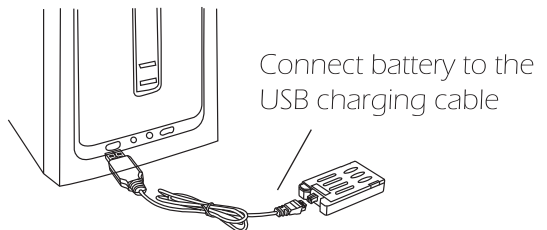
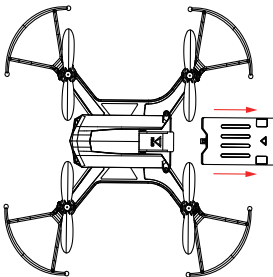

CAUTIONS

- 1) Don't use or charge the battery if it shows signs of swelling, punctures, or is damaged in any way.
- 2) Don't charge the battery directly after use, allow it to cool down in an open and dry area to insure overheating does not occur.
- 3) During charging, please keep the battery away from furniture, carpet or anything flammable.
- 4) Do not overload the battery(below 5V/2A). Make sure to remove the battery from the charger after charging is complete, never overcharge the battery.
- 5) Be cautious while removing a battery from the charger, it's possible to strip the cords that could lead to a fire(and ruin the battery)



Li-Po Battery Disposal & Recycling

Wasted Lithium-Polymer batteries must not be placed with household trash. Please contact local environmental or waste agency or the supplier of your model or your nearest Li-Po battery recycling center.



< ASSEMBLE THE DRONE >

As the speed of this drone is very fast, we suggest the pilot install the propeller guards before flying. Please install and remove the propeller guards according to the diagrams below.

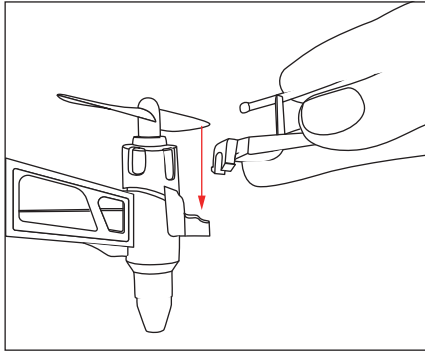

Install all four propeller guards into the holes located on the motor bases.

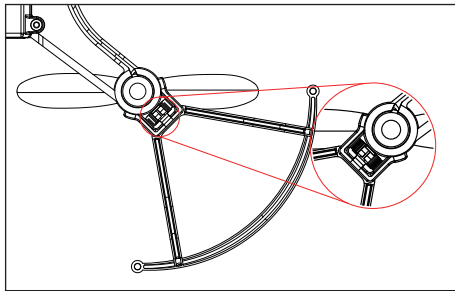

Press the buckle on the propeller guard, and you can take propeller guard out.

Safe Fly Information



+



+



Fly in Open Areas

Maintain Line
of Sight

Fly Below
80 m



Avoid flying over or near obstacles, crowds, high voltage power lines, trees, airport or bodies of water.

DO NOT fly near strong electromagnetic sources such as power lines and base stations as it may affect the onboard compass.



DO NOT use the drone in adverse weather conditions such as rain, snow, fog and wind exceeding **3.3 m/s** or **11 mph**.

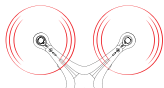

No Fly Zone

Stay away from the rotating propellers and motors.



The basic flight guidelines are important for pilots' safety and the surroundings. Please read the Safety Guidelines carefully.

- ⚠ • Rotating propellers can be dangerous. Do not start the motors when there are people nearby.
- Always keep your hands on the transmitter so long as the motor is still spinning.

Pair the Drone:

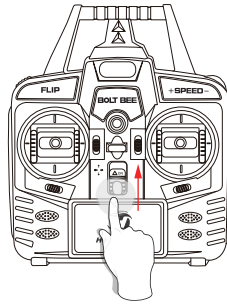
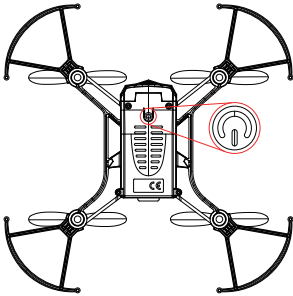

- ① Power on the drone first, now the LED indicator lights on the drone will start blinking.
- ② Then, power on the transmitter.

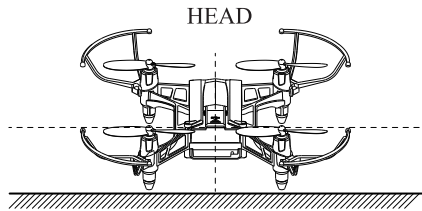

- ③ Place the drone on a level surface, and make sure the tail of drone faces the pilot.

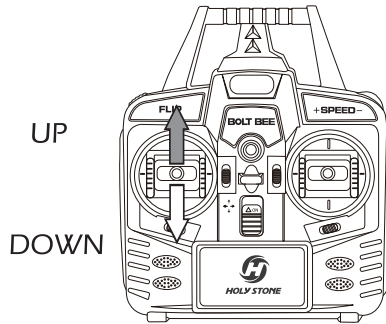

- ④ Push the left joystick up then down. One beep will be heard, and the drone lights will stop blinking and turn solid, which indicates the transmitter is connected to the drone successfully.

Calibrate the Gyro:

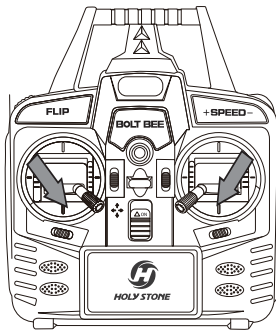

- ⑤ After pairing, pull and hold left joystick down to the bottom right and the right joystick down to the bottom left at the same time. A beep sound will be heard from the transmitter and the LED lights on the drone will be blink, then turn solid, indicating that the calibration setting is completed.

(To ensure a stable flight, we suggest the pilot calibrate the gyro after pairing the drone every time and after a crash.)

Flight Control:



⑥ Left (Throttle) Joystick.

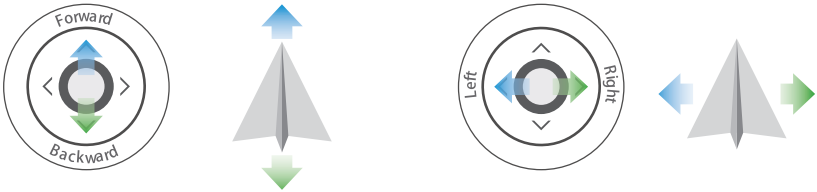

⑦ Right (Direction) Joystick.

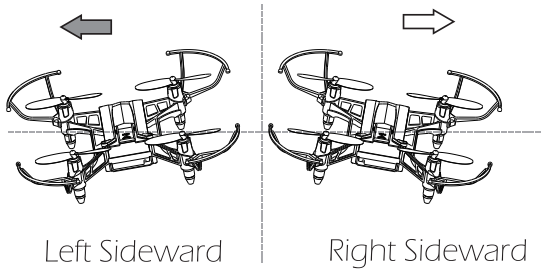
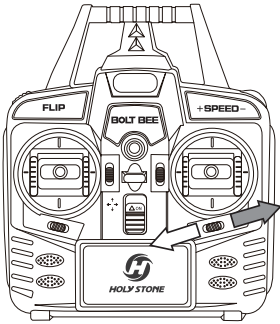

⑧ **Left/ Right Sideward Fly Trim:** When the drone drifts to left or right side, slide the trim button to the opposite direction to re-balance the drone. (If this drone drifts to right, slide this trim button to left; if it drifts to left, slide this trim button to right.)

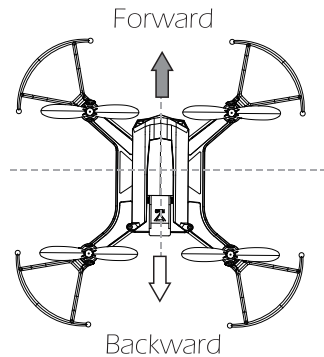
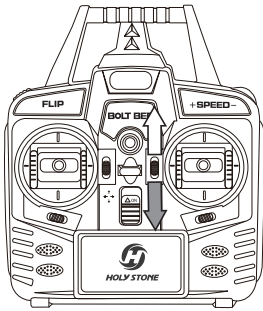

- ⑨ **Forward/ Backward Sideward Fly Trim:** When the drone drifts to forward or backward, slide the trim button to the opposite direction to re-balance the drone. (If this drone drifts to forward, slide this trim button to backward; if it drifts to backward, slide this trim button to forward.)

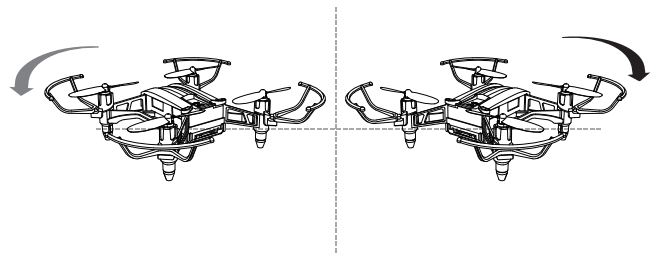
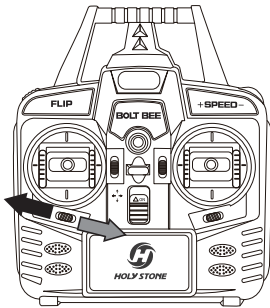

- ⑩ **Rotate to Left/Right Trimmer:** When the drone rotates to left or right side automatically, slide the trim button to the opposite direction to re-balance the drone. (If this drone rotates to left, slide this trim button to right; if it rotates to right, slide this trim button to left.)



Important:

The range for the reliable communication between the drone and the transmitter is around 240 feet (80 meters) depending on terrain and conditions. If the drone loses signal at any point, it will lose control or drop from the sky by itself.

< LOW BATTERY WARNING >

- ① When the drone battery runs low, the indicator lights on the drone will start blinking slowly, and the transmitter will constantly beep three times every one second. When this happens, the pilot should land the drone safely and charge the battery.
- ② When the transmitter battery runs low, the indicator lights on the transmitter will start blinking and you will hear a beep every 5 seconds.

< FLIP MODE >

When you become familiar with all the functions of the drone, you can try this amazing flip mode. Make sure you fly the drone at least 10 feet high, press the Flip button at the upper left corner of the transmitter, then push the Right Joystick to the Forward/Backward Left/Right, and the drone will do a flip towards the corresponding direction.

Caution: The drone will flip best when the battery is fully charged.

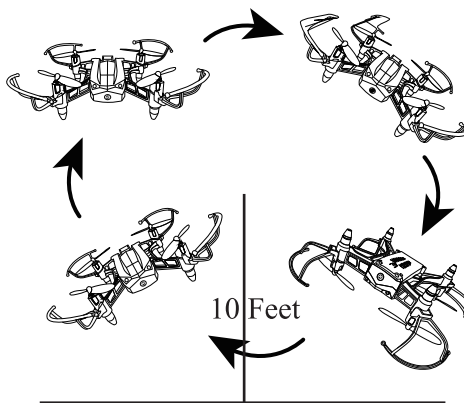

< HEADLESS MODE >

⚠ Do not use the Headless Mode until you totally comprehend the Instructions For Use. Flying in Headless Mode without sufficient experience might result in loss or damage of the device.

1. Place the drone in front of the pilot before pairing the drone to transmitter. Make sure the head of the drone faces forward and the tail faces towards the pilot..

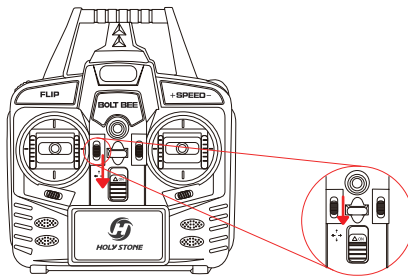

2. Push the left joystick up then down to pair the transmitter to the drone.
3. Slide the Headless Mode button down to enter Headless Mode. The drone lights will start blinking and you will hear one beep sound from the transmitter.
4. Slide the Headless Mode button down again, (You will hear three beeps sound and the drone lights will turn solid) the drone will exit Headless Mode.

< HEADLESS MODE >

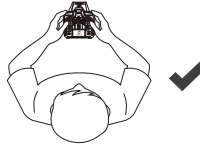
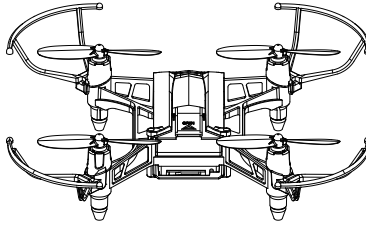

The direction of control when the drone is paired



Don't turn your direction



Don't turn your direction

Under Headless Mode, the forward direction is the direction the pilot faces when the pilot pairs the drone with the transmitter. If the pilot pushes the direction joystick forward, the drone will fly away from him/her. If the pilot pushes the direction joystick backward, the drone will fly towards him/her. If the pilot move the direction joystick left or right, the drone will also move left or right relative to him/her. It is very important that the pilot does not change positions or the direction he or she faces, otherwise the drone will get confused.

< TROUBLE SHOOTING >

Problems	Reasons	Solutions
The lights on the drone are blinking, but the drone can not respond to the transmitter.	<ol style="list-style-type: none"> 1. Insufficient battery power. 2. Transmitter is not connected with the drone. 3. Unbalanced landing position. 4. Drone cannot be paired because the drone has been on for a long period of time. 	<ol style="list-style-type: none"> 1. Fully charge the battery. 2. Turn off the drone and transmitter, then reconnect them by turning them on again. 3. Place the drone in a level surface when pairing. 4. Turn off the drone and transmitter, then turn them on again to pair.
One or two propellers won't spin.	<ol style="list-style-type: none"> 1. Propellers are caught in motor base. 2. Motor shaft is bent or caught in motor base. 3. Motors burnt out 	<ol style="list-style-type: none"> 1. Replace the propellers . 2. Adjust the motor shaft with a pair of pliers 3. Replace the motors.
The propellers spin, but the drone can't fly.	<ol style="list-style-type: none"> 1. Insufficient battery power. 2. Propellers are installed in the wrong orientation. 3. Damaged propellers. 4. Something caught in the propellers or gears. 	<ol style="list-style-type: none"> 1. Fully charge the battery. 2. Check whether propeller A and propeller B are installed correctly according to diagram on page 3 of this manual. 3. Replace old propellers with new ones. 4. Ensure gears and propellers are cleaned that there is nothing caught in them.
The drone doesn't fly properly after a crash.	<ol style="list-style-type: none"> 1. Propellers are not installed in the correct orientation. 2. Damaged propellers. 3. the gyro is out of calibration 4. Propellers have hit the propeller guard. 5. Wire or circuit board is broken. 6. Motors burn out. 	<ol style="list-style-type: none"> 1. check the position of the propellers. 2. Replace propellers with new ones. 3. Reset the the gyro or slide trim buttons to adjust the direction. 4. Make sure the propellers work well. 5. Replace the circuit board. 6. Replace the motors.

Please do not hesitate to contact us if you need further support.



usa@holystone.com (USA)
ca@holystone.com (CA)

eu@holystone.com (EU)
jp@holystone.com (JP)



+1(855) 888-6699

GENERAL INFORMATION

FCC Notice:

This device complies with Part 15 of the FCC Rules.

Operation is subject to the following two conditions:

- (1) This device may not cause harmful interference.
- (2) This device must accept any interference received, including interference that may cause undesired operation.

NOTE: This equipment has been tested and found to comply with the limits for a Class B digital device, pursuant to Part 15 of the FCC Rules. These limits are designed to provide reasonable protection against harmful interference in a residential installation. This equipment generates uses and can radiate radio frequency energy and, if not installed and used in accordance with the instructions, may cause harmful interference to radio communications. However, there is no guarantee that interference will not occur in a particular installation. If this equipment does cause harmful interference to radio or television reception, which can be determined by turning the equipment off and on, the user is encouraged to try to correct the interference by one or more of the following measures:

- Reorient or relocate the receiving antenna.
- Increase the separation between the equipment and receiver.
- Connect the equipment into an outlet on a circuit different from that to which the receiver is connected.
- Consult the dealer or an experienced radio/TV technician for help.

WARNING: Changes or modifications not expressly approved by the party responsible for compliance could void the user's authority to operate the equipment.

RF Exposure

The equipment complies with FCC radiation exposure limits set forth for an uncontrolled environment. This device should be installed and operated with minimum distance 20cm between the radiator & your body.

Please separate your device from other types of waste to recycle it responsibly. This will help to foster the sustainable re-use of material resources.

IC Notice:

This device complies with Canada Industry licence-exempt RSS standard(s). Operation is subject to the following two conditions:

- (1) this device may not cause interference; and
- (2) this device must accept any interference. Including interference that may cause undesired operation of the device.

CAN ICES-3 (B)

Avis d'Industrie Canada

Le présent appareil est conforme aux CNR d'industrie Canada applicables aux appareils radio exempts de licence. L'exploitation est autorisée aux deux conditions suivantes:

- 1) l'appareil ne doit pas produire de brouillage; et
 - 2) l'utilisateur de l'appareil doit accepter le brouillage radioélectrique subi même si le brouillage est susceptible d'en compromettre le fonctionnement.
- Le mauvais fonctionnement de l'appareil. Cet appareil numérique de la classe B est conforme à la norme NMB-003 du Canada.

CAN NMB-3 (B)

RF Exposure

Radiation Exposure Statement:

This equipment complies with IC radiation exposure limits set forth for an uncontrolled environment. This equipment should be installed and operated with minimum distance 20cm between the radiator & your body.

Déclaration d'exposition aux radiations:

Cet équipement est conforme aux limites d'exposition aux rayonnements IC établies pour un environnement non contrôlé. Cet équipement doit être installé et utilisé avec un minimum de 20 cm de distance entre la source de rayonnement et votre corps.

HOW TO RECYCLE THIS PRODUCT

This symbol on the product or its documentation indicates that it must not be disposed of with household waste.

Uncontrolled waste disposal may harm the environment or human health.

We invite you to contact your retailer or inquire at your local town hall to find out where and how the drone can be recycled.



BATTERY WAENING:

- 1.Failure to follow all the instructions may result in serious injury, irreparable damage to the battery and may cause a fire, smoke or explosion.
- 2.Always check the battery's condition before charging or using it.
- 3.Replace the battery if it has been dropped, or in case of odour, overheating, discolouration, deformation or leakage.
- 4.Never use anything other than the approval LiPo charger the battery. Always use a balancing charger for LiPo cells or a LiPo cell balancer. It is recommended that you do not to use any other charger than the one provided with the product.
- 5.The battery temperature must never exceed 60°C(140°F) otherwise the battery could be damaged or ignite.
- 6.Never charger on a flammable surface, near flammable products or inside a vehicle (perferably place the battery in a non-flammable and non-conductive container).
- 7.Never leave the battery unattended during the charging process. Never disassemble or modify the housing's wiring, or puncture the cells. Always ensure that the charger output voltage corresponds to the voltage of the battery. Do not short circuit the batteries.
8. Never expose the LiPo battery to moisture or direct sunlight, or store it in a place where temperatures could exceed 60°C(car in the sun, for example).
- 9.Always keep it out of reach of children.
- 10.Improper battery use may result in a fire, explosion or other hazard.
- 11.Non-rechargeable batteries are not to be recharged. Rechargeable batteries are only to be charged under adult supervision.
- 12.Different types of batteries or new and used batteries are not to be mixed.
- 13.Batteries are to be inserted with the correct polarity.
- 14.The supply terminals are not to be short-circuited. Regular examination of transformer or battery charger for any damageto their cord, plug, enclosure and other parts and they must not be used until the damage has been repaired.

15.The packaging has to be kept since it contains important information.

16.The toy is only to be connected to Class II equipment bearing the symbol. 

Caution

1.Risk of explosion if battery is replaced by an incorrect type. Dispose of used batteries according to the instructions.

2.The max operating of the EUT is 45°C. and shouldn't be lower than -10°C.

3.The device complies with RF specifications when the device used at 0mm form your body.

4.Declaration of Conformity

EU RF Power(EIRP):-22.75dBm(2404MHz ~ 2480MHz)

We, Xiamen Huoshiquan Import & Export CO., LTD

hereby, declare that the essential requirements compliance with the Directive 2014/53/EU, the RoHS Directive 2011/65/ EU and Safety Directive 2009/48/EC have been fully fulfilled on our product with indication below:

Product Name: Remote control four axis series

Model /Trademark: HS150/HOLY STONE

The Statement of compliance is available at the following address:

http://www.holystone.com/Download/CE/HS150_EU_DOC.pdf

This product can be used across EU member states.

MANUFACTURER INFORMATION

Manufactured by

Xiamen Huoshiquan Import & Export CO., LTD

Room 703,No. 813-2 Xiahe Road, Siming District, XIAMEN, China

+1(855) 888 -6699



Made in China